

# SPECTRORADIOMETER CS-2000/CS-2000A

**En** Instruction Manual



Please read before using the instrument.



KONICA MINOLTA

# Safety Symbols

---

The following symbols are used in this manual to prevent accidents which may occur as a result of incorrect use of the instrument.



Denotes a sentence regarding a safety warning or note.  
Read the sentence carefully to ensure safe and correct use.



Denotes a prohibited operation.  
The operation must never be performed.



Denotes an instruction.  
The instruction must be strictly adhered to.



Denotes an instruction.  
Disconnect the AC adapter from the AC outlet.



Denotes a prohibited operation.  
Never disassemble the instrument.



Denotes alternating current (AC).



Denotes direct current (DC).













Denotes class II protection against electric shock.

## Notes on This Manual

- Copying or reproduction of all or any part of the contents of this manual without KONICA MINOLTA's permission is strictly prohibited.
- The contents of this manual are subject to change without prior notice.
- Every effort has been made in the preparation of this manual to ensure the accuracy of its contents. However, should you have any questions or find any errors, please contact the nearest **KONICA MINOLTA**-authorized service facility.
- KONICA MINOLTA will not accept any responsibility for consequences arising from the use of the instrument.

# Safety Precautions

To ensure correct use of this instrument, read the following points carefully and adhere to them. After you have read this manual, keep it in a safe place where it can be referred to anytime a question arises.

	<b>Warning</b> (Failure to adhere to the following points may result in death or serious injury.)
	Do not use this instrument in places where flammable or combustible gases (gasoline etc.) are present. Doing so may cause fire.
	Always use the AC adapter and power cord supplied as a standard accessory or optional (AC-A312), and connect it to indoor AC outlet of rated voltage and frequency (100 - 120 V ~ or 200 - 240 V ~, 50/60Hz). Failure to follow either of these may result in damage to unit, fire or electric shock.
	If this instrument is not used for a long time, disconnect AC adapter from AC outlet. Accumulated dirt or water on prongs of AC adapter plug may cause fire and should be removed.
	Do not forcibly pull any part on power cord when unplugging since this may cause fire or electric shock. Gently disconnect by holding plug. Also, do not handle power cord with wet hands. Doing so may cause electric shock.
	Do not forcibly bend, twist or pull power cord. Also, do not place heavy object on power cord, or damage or modify one. Any of these may cause fire or electric shock due to damage to power cord.
	Do not disassemble or modify this instrument or AC adapter. Doing so may cause fire or electric shock.
	Do not spill liquid on this instrument or drop metal into this instrument. Should either of these happen, switch power off, unplug AC adapter immediately and contact the nearest <b>KONICA MINOLTA</b> authorized service facility.
	Should this instrument or AC adapter be damaged or smoke or odd smell be generated, do not keep using such instrument or AC adapter without correction. Doing so may cause fire. In such situations, switch power off immediately, unplug AC adapter and contact the nearest <b>KONICA MINOLTA</b> authorized service facility.
	Do not look at sun or intense light through finder of this instrument. This may lose your sight.



## Caution

(Failure to adhere to following points may result in injury or damage to this instrument or other property.)



Use this instrument near AC outlet for easy plugging or unplugging in using AC adapter.



Do not place this instrument on unstable or sloping surface which may drop or overturn it. Dropping or overturning may injure someone around. Take care not to drop this instrument when carrying it.



Do not move while looking inside finder since this would fall or injure user.



Take special care in handling the ND filter or closeup lens included in the optional accessories. Breakage of the ND filter or closeup lens may injure someone around.

# Introduction

---

This instrument is a high-accuracy spectroradiometer designed to measure luminance and chromaticity up to super-low luminance regions. Carefully read this manual before using one.

## **Packaging material**

Be sure to save all packaging materials (corrugated cardboard boxes, pads and plastic bags) supplied with the purchase. This is delicate measurement instrument. Use packaging materials supplied in purchasing in case this instrument needs to be transferred for such purpose as maintenance in KONICA MINOLTA's factories. These packaging materials are useful for minimizing shock or vibration to this instrument in such situation.

Should any of these packaging materials be lost or broken, please contact the nearest **KONICA MINOLTA** authorized service facility.

## **Note on Use**

### **Operating Environment**

- The standard AC adapter (AC-A312) of this instrument is designed specifically for use indoors. Do not use it outdoors.
- Do not disassemble this instrument for being composed of delicate electronic components.
- Use this instrument at rated voltage of 100 V - 120 V ~ or 200 V - 240 V ~ (50/60Hz). Connect AC power cord to AC outlet with rated voltage and frequency. Connected voltage should not be outside the range of  $\pm 10\%$  of nominal.
- This instrument is classified into a Pollution Degree 2 as instrument used in mainly in manufacturing plant, laboratory, warehouse or equivalents. Use this instrument in metal dust free and non condensing potential environment.
- This instrument is categorized into Installation Category II as equipment connected to commercially available power source.
- This instrument and the AC adapter are EMC Class B products. Use of the instrument and the AC adapter in home environments may cause radio interference. Users may be required to take appropriate measures in such cases.
- Connect PC for controlling this instrument to the outlet with protective grounding. Failure to follow this may result in electric shock due to short circuit.
- Take care not to enter foreign substance like water or metal in this instrument. Operating in such state cause serious danger.
- Do not use this instrument under direct sunlight or near heater. The internal temperature of this instrument to becomes much higher than ambient temperature which may break this instrument. Also, use this instrument in a well-ventilated place. To ensure proper heat dissipation, keep the ventilation holes free from obstructions.
- Avoid rapid change in ambient temperature which may form dew condensation.
- Avoid using this instrument in extremely dusty or humid place.
- Use the CS-2000 at ambient temperature between 5 and 35°C and relative humidity 80% or less (at 35°C) with no condensation. Use the CS-2000A at ambient temperature between 5 and 30°C and relative humidity 80% or less (at 30°C) with no

---

condensation. Operating this instrument outside specified temperature and humidity range may not satisfy its original performance.

- Do not use the instrument at altitudes higher than 2,000 m.
- Make sure the AC adapter output plug is not short-circuited. A short-circuit may cause a fire or electric shock.
- Do not connect the AC adapter to an overloaded electrical circuit. In addition, do not cover or wrap the AC adapter with cloth or other material while in use. Doing so may cause electric shock or fire.
- When removing the AC adapter from the instrument, first remove the power cord from the outlet, and then remove the output plug.

### **This Instrument**

- Do not subject this instrument to strong impact or vibration.
- Do not forcibly pull, bend, or apply strong force to power cord for attached AC adapter or USB cable. This may result in snapping.
- Connect this unit to power source with minimal noise.
- Do not measure a high-luminance light source (including sunlight) beyond the measurement range. The failure to observe this warning could result in damage to the optical system.
- Should breakage or abnormality be found during operation, switch power off immediately and unplug. Then refer to “Error Check” on page 84.
- Should this instrument break down, do not try to disassemble and repair it by yourself. Please contact the nearest **KONICA MINOLTA** authorized service facility.
- Warm this instrument up for 20 minutes at least after switching power on when the object luminance is 2 cd/m<sup>2</sup> or lower (measuring angle 1°).
- When not using RS-232C communication, make sure to attach the connector cap. Failure to do so may cause malfunction due to static electricity.

### **Objective lens, ND filter and Closeup lens (Optional Accessories)**

- Make sure that surfaces of objective lens, ND filter or closeup lens are clear. Correct measurement may not be performed if there is dirt, dust, hand soil or part left unclean.
- Do not touch surface of objective lens, ND filter or closeup lens with hand.
- Do not change ambient temperature rapidly under high humidity. This may mist objective lens, ND filter or closeup lens, resulting in incorrect measurement.

### **Note on Storage**

#### **Body**

- Do not store this instrument under direct sunlight or near heater. The internal temperature of this instrument becomes much higher than ambient temperature which may break this instrument.

- 
- Store this instrument at ambient temperature between 0 and 35°C and relative humidity 80% or less (at 30°C) with no condensation. Storage under high temperature and humidity may deteriorate performance of this instrument. For added safety, we recommend storage with such drying agent at room temperature.
  - Take care not to form condensation. Avoid rapid change in ambient temperature when transferring body for storage.
  - Put the body in a packaging box supplied when purchased or the storage case (CS-A30) in the optional accessories to store in safe place.

### **Objective lens**

- For storage, cover the objective lens with standard accessory lens cap.

## **Cleaning**

### **Body**

- If this unit becomes dirty, wipe with dry and soft cloth. Do not use organic solvent like naphtha or thinner and other chemical agent for cleaning. Should none of these methods be helpful, please contact the nearest **KONICA MINOLTA** authorized service facility.

### **Objective lens**

- Should it be gotten dirt or dust, wipe off with dry and soft cloth or lens cleaning paper. Do not use organic solvent like naphtha or thinner and other chemical agent for cleaning. Should none of these methods be helpful, please contact the nearest **KONICA MINOLTA** authorized service facility.

## **Notes on Transfer**

- Use packaging material supplied when purchased to minimize vibration or shock generated during transfer.
- Put all material including unit and accessories in original packaging material when returning this instrument for service.

## **Maintenance**

- Periodical checkup is recommended annually to maintain measurement accuracy of instrument. For details on checkup, please contact the nearest **KONICA MINOLTA** authorized service facility.

## **Disposal Method**

- Make sure that the CS-2000/CS-2000A, its accessories and the packing materials are either disposed of or recycled correctly in accordance with local laws and regulations.

# Contents

<b>Safety Precautions</b> .....	<b>1</b>
<b>Introduction</b> .....	<b>3</b>
<b>Note on Use</b> .....	<b>3</b>
Operating Environment .....	3
This Instrument .....	4
Objective lens, ND filter and Closeup lens (Optional Accessories) .....	4
<b>Note on Storage</b> .....	<b>4</b>
Body .....	4
Objective lens .....	5
<b>Cleaning</b> .....	<b>5</b>
Body .....	5
Objective lens .....	5
<b>Notes on Transfer</b> .....	<b>5</b>
<b>Maintenance</b> .....	<b>5</b>
<b>Disposal Method</b> .....	<b>5</b>
<b>Standard Accessories</b> .....	<b>8</b>
<b>Optional Accessories</b> .....	<b>9</b>
<b>System Configuration</b> .....	<b>11</b>
<b>Names and Functions of Parts</b> .....	<b>12</b>
Names of Each Part .....	12
Functions of Each Part .....	13
Key Panel .....	14
Main Functions of Each Key .....	14
Diopter Adjustment .....	15
<b>LCD Screen</b> .....	<b>16</b>
MEAS (Measurement value) screen .....	16
MENU screen .....	17

## Installation

<b>Installing</b> .....	<b>20</b>
<b>Connecting AC Adapter</b> .....	<b>21</b>
<b>Connection Method</b> .....	<b>22</b>
<b>Power Switch ON(   )/OFF(O)</b> .....	<b>23</b>
Turning power switch ON .....	23
Turning power switch OFF .....	23

## Setting

<b>Setting of Synchronization</b> .....	<b>26</b>
<b>Selecting Measurement Time</b> .....	<b>29</b>
<b>Setting Observer</b> .....	<b>35</b>
<b>Selecting Display Format</b> .....	<b>37</b>
<b>Selecting Color Space</b> .....	<b>39</b>
<b>Selecting Absolute Value (ABS)/ Difference (DIFF) Display</b> .....	<b>41</b>
<b>When Using Closeup Lens</b> .....	<b>43</b>
<b>When Using ND Filter</b> .....	<b>45</b>
<b>Calibration</b> .....	<b>47</b>
Calibration Channel .....	47
<b>Backlight ON/OFF During Measurement</b> .....	<b>49</b>
<b>Baud Rate Selection for RS-232C Communication</b> .....	<b>51</b>



---

<b>Measurement</b>
--------------------

<b>Measurement</b> .....	<b>54</b>
<b>Saving the Measurement Value</b> .....	<b>57</b>
<b>Deleting the Memory Data</b> .....	<b>60</b>
<b>Registering Target Color</b> .....	<b>63</b>
Target color .....	63
<b>Selecting Target Color</b> .....	<b>67</b>
<b>Deleting Target Color</b> .....	<b>69</b>

<b>Communication</b>
----------------------

<b>Connecting to PC</b> .....	<b>74</b>
Connection via USB cable .....	74
Connection via RS-232C cable.....	75
<b>Remote Mode</b> .....	<b>76</b>

<b>Explanation</b>
--------------------

<b>Measurement Principle</b> .....	<b>78</b>
Sensor Section .....	78
<b>Dark Measurement</b> .....	<b>78</b>
<b>L<sub>v</sub>T<sub>Δuv</sub></b> .....	<b>79</b>
<b>Dominant wavelength/ Excitation purity</b> .....	<b>80</b>
<b>Measurement of Object Color</b> .....	<b>81</b>
Necessary Setting for Object Color Measurement .....	81
White Calibration .....	81
Measurement of Object .....	81
<b>Dimensions</b> .....	<b>82</b>
<b>Error Message</b> .....	<b>83</b>
<b>Error Check</b> .....	<b>84</b>
<b>Setting Initialization</b> .....	<b>88</b>
<b>Switching Luminance Unit</b> .....	<b>89</b>
<b>Main Specifications</b> .....	<b>90</b>

# Standard Accessories

Standard and optional accessories are available with the instrument.

**Memo** The shape of some products may be different from those shown.

## Lens Cap CS-A31

- Attached to objective lens for protecting it when not using this instrument.

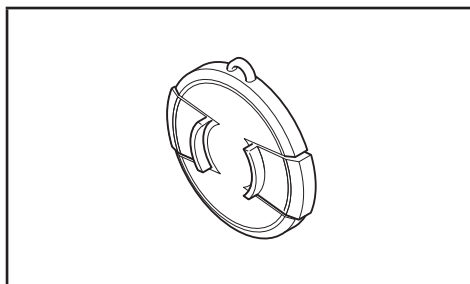

## USB Cable (2 m) CS-A32

- Used for communication between this instrument and PC.

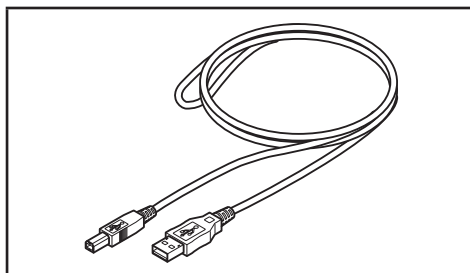

## AC Adapter AC-A312

- Supplies power from AC outlet.  
Input: 100 - 120 V  $\sim$  or 200 - 240 V  $\sim$   
0.75 - 0.42 A  
50/60 Hz  
Output: 12 V  $\equiv$  3 A  
Plug design  $\oplus$   $\ominus$  Center-negative

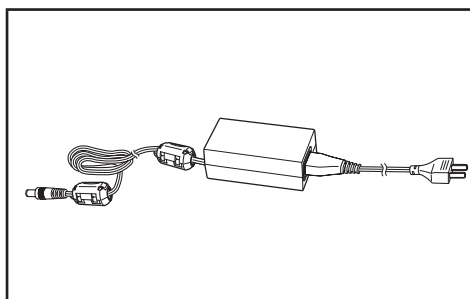

## Screw for focus ring lock CS-A38

- Locks the focus adjustment ring of the CS-2000/CS-2000A so that it does not move unintentionally and change the focus.
  - Do not use any screw except for the attached screw. Should it be lost or damaged, purchase a new CS-A38.
  - When storing the CS-2000/CS-2000A in the Storage Case (optional accessory), remove the screw.
  - When storing the CS-2000/CS-2000A in the packing box for transfer, remove the screw.

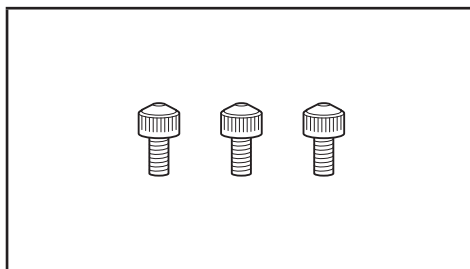

## Data Management Software

### CS-S10w Professional

- Software to control this instrument from PC for various data management.
- The protect key is attached.

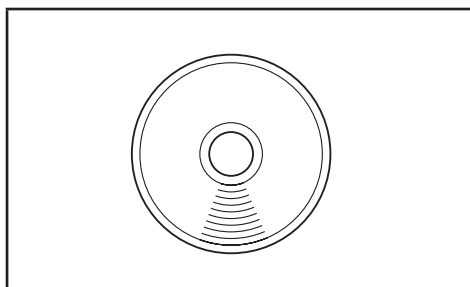

# Optional Accessories

---

## Calibration Certificate

### ND Eyepiece Filter CS-A1

- Reduces glare during observation through the finder when a high-luminance object is measured. Be sure to place this filter in front of the finder when measuring high-luminance objects.

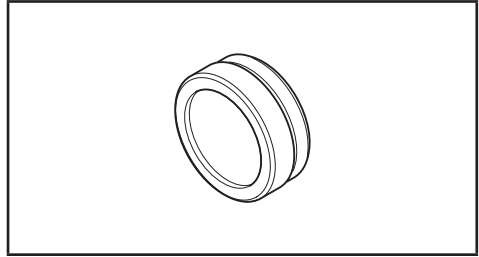

### ND Filter (1/10) CS-A33

### ND Filter (1/100) CS-A34

- Placed in front of objective lens for measurement of high luminance object.

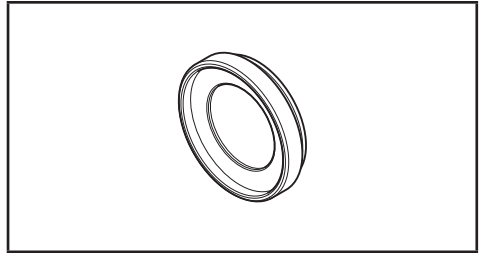

### Calibration Certificate (for ND filter)

- Calibration certificates can be attached to the ND filters (1/10) CS-A33 and (1/100) CS-A34.

### Closeup Lens CS-A35

- Placed in front of objective lens for measurement of small object.

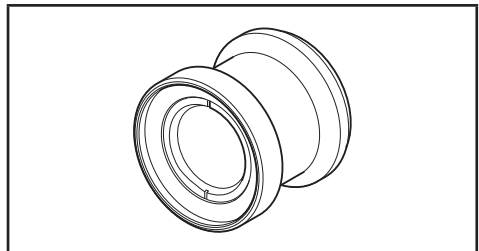

### Adapter for CCD camera CS-A36

- Placed between the finder and the body when a C-mount industrial camera is used.

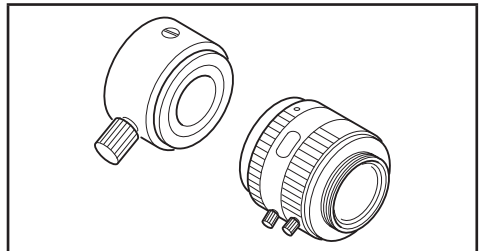

### White Calibration Plate CS-A5 (without data)

### White Calibration Plate CS-A5 (with data)

### White Calibration Plate CS-A5 (with data and calibration certificate)

- Used for measurement of object colors. Three types (named, not-named, named with calibration certificate) are prepared.

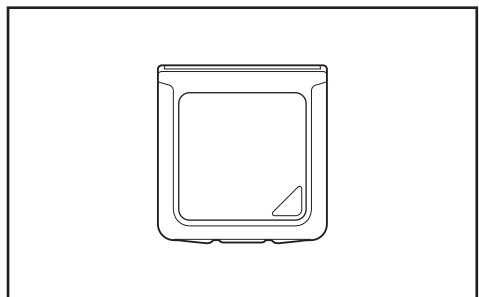

---

**Tripod CS-A3****Pan Head CS-A4**

- Used when installing this instrument.

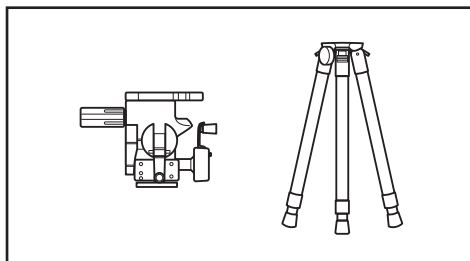
**Storage Case CS-A30**

- Used to house the instrument and accessories or to carry them by hand. Never use this as a transport case.

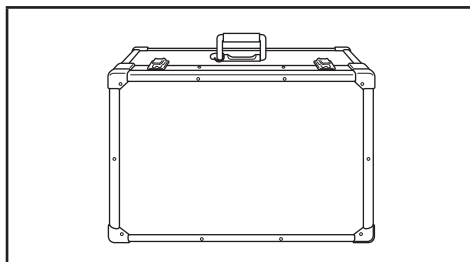
**RS-232C cable (5 m) IF-A37****RS-232C cable (10 m) IF-A38**

- Used to connect the instrument to the RS-232C interface on a PC.

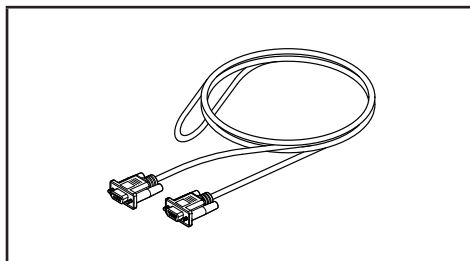

# System Configuration

———— Standard Accessories

----- Optional Accessories

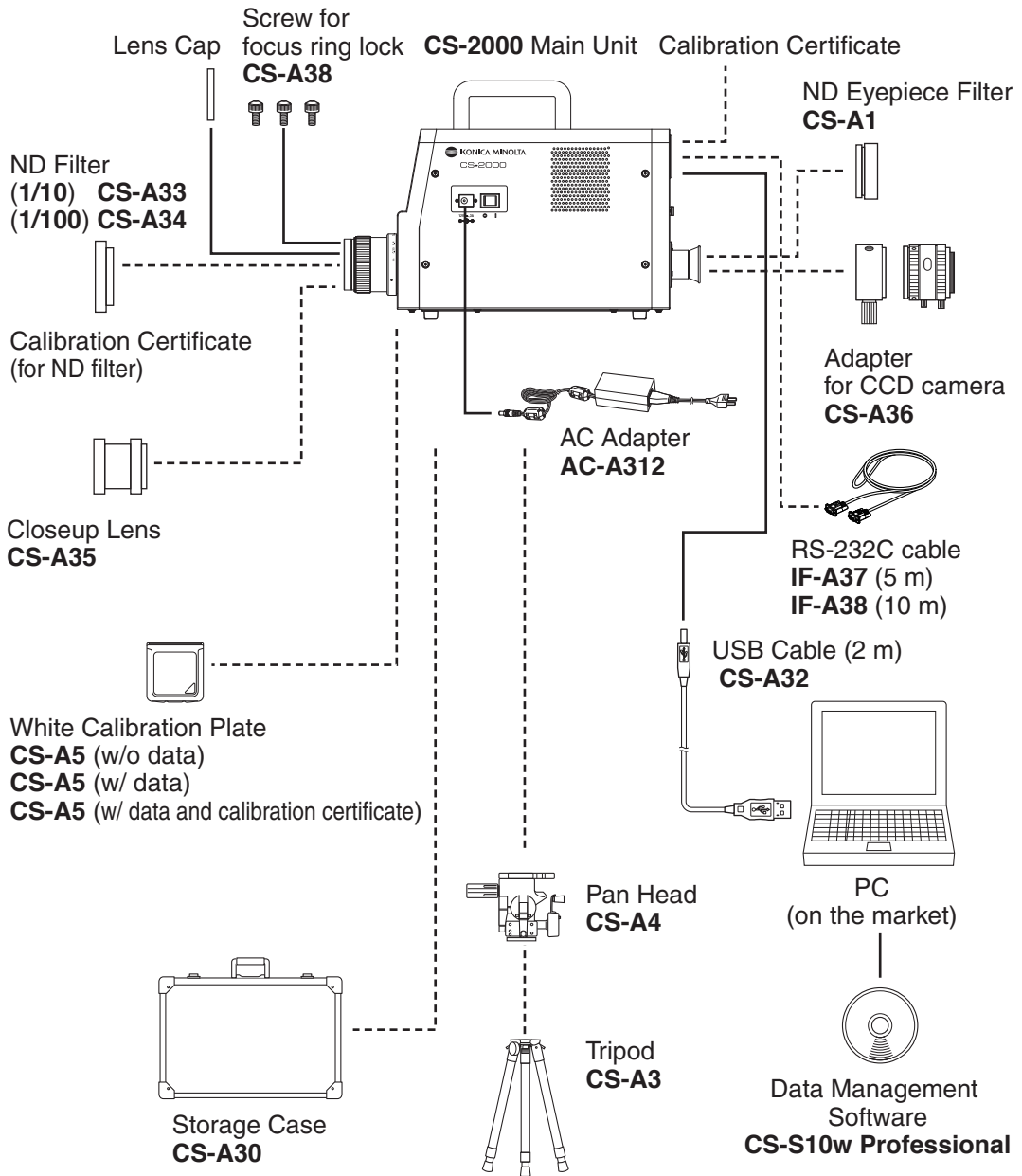

# Names and Functions of Parts

## Names of Each Part

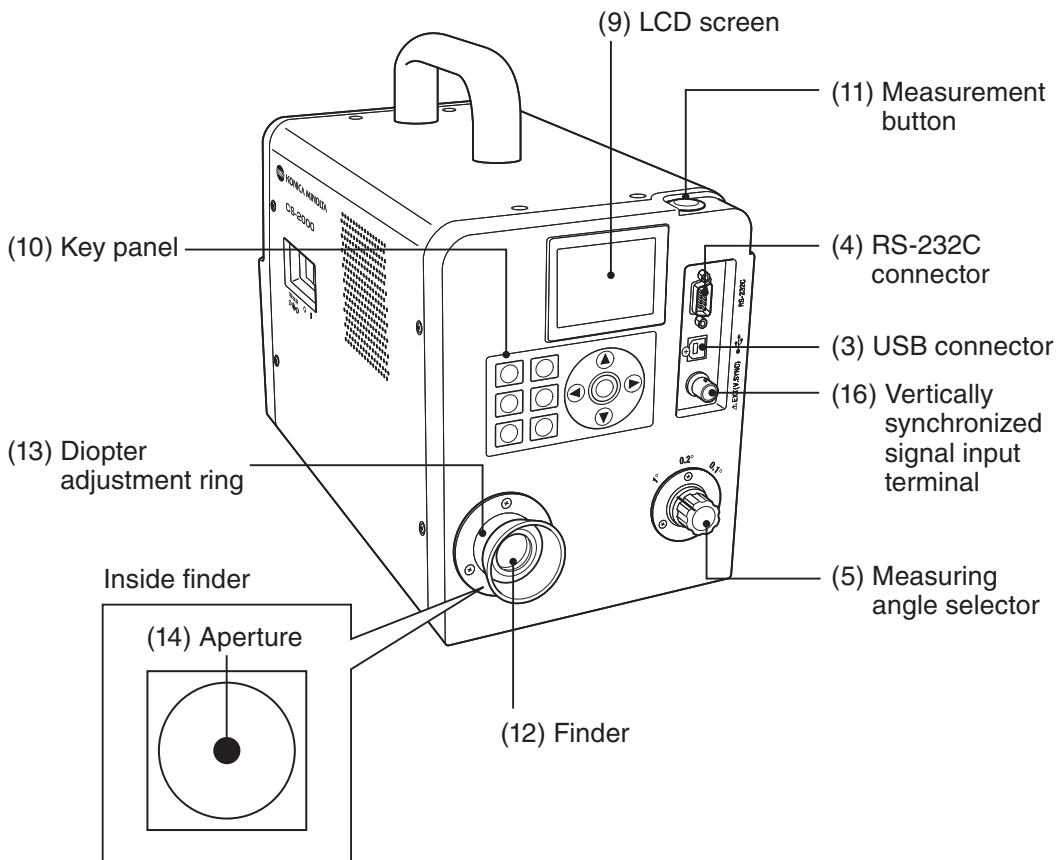
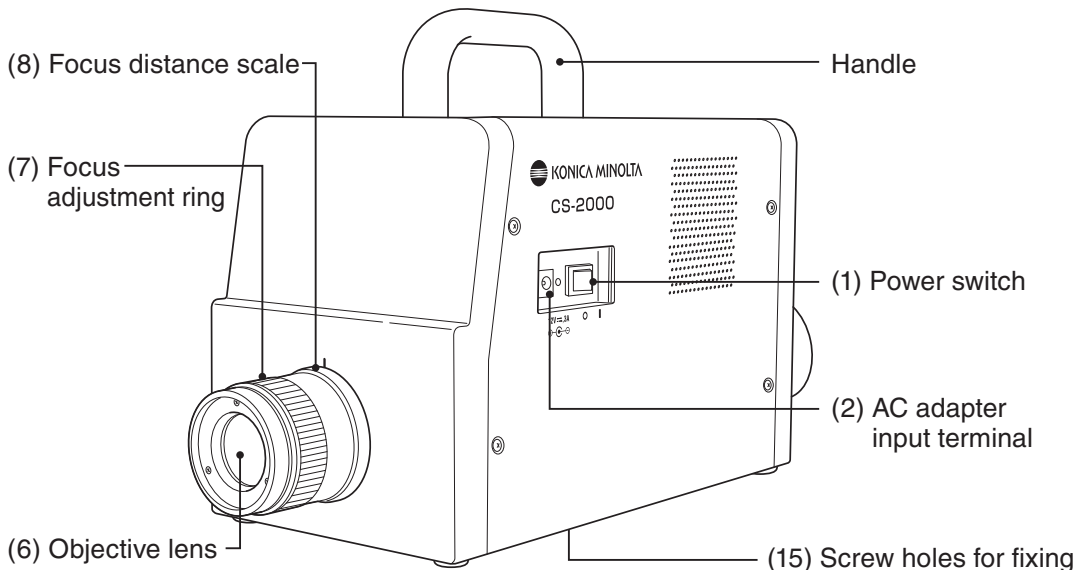

---

## Functions of Each Part

- (1) **Power switch** Switches this instrument on/off. ( | ) for ON; ( O ) for OFF. ... (p.23)
- (2) **AC adapter input terminal** Connects the attached AC adapter. .... (p.21)
- (3) **USB connector** Connects the USB cable when connecting to PC. .... (p.74)
- (4) **RS-232C connector** Connects the RS-232C cable when connecting to PC. ... (p.75)
- (5) **Measuring angle selector** Selects measurement angle among 1°, 0.2° and 0.1°. .... (p.54)
- (6) **Objective lens** Directed to object for measurement. .... (p.55)
- (7) **Focus adjustment ring** Adjusts focus of objective lens before measurement. .... (p.55)
- (8) **Focus distance scale** Helps adjusting focus. .... (p.55)
- (9) **LCD Screen** Displays various screens like measurement and menu. ... (p.16)
- (10) **Key Panel** Offers several keys for operation of this instrument. .... (p.14)
- (11) **Measurement button** For measurement. .... (p.55)
- (12) **Finder** Used to observe object for measurement. .... (p.15, 55)
- (13) **Diopter adjustment ring** Adjusts diopter. .... (p.15, 55)
- (14) **Aperture** Indicates measuring area. .... (p.55)  
Size of black circle will change depending on measuring angle.

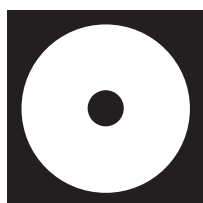

**1° Aperture**

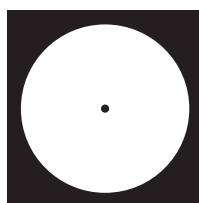

**0.2° Aperture**

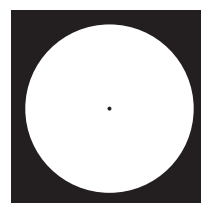

**0.1° Aperture**

- (15) **Screw holes for fixing** Used to fix this instrument with tripod or jig. .... (p.20)
- (16) **Vertically synchronized signal input terminal** Connects the cable to input the vertically synchronized signal or the external sync measurement. .... (p.26)

---

## Key Panel

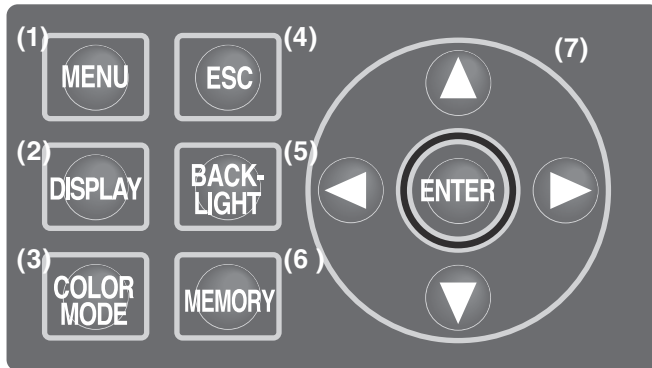

### Main Functions of Each Key

- (1) **MENU key**                    The MENU screen appears if this key pressed when the measurement value screen appears. (p.17)
- (2) **DISPLAY key**                    Selects whether chromaticity is displayed in absolute value (ABS) or difference (DIFF) if this key pressed when the measurement value screen appears. (p.41)
- (3) **COLOR MODE key**                    Color space modes are switched in turn as follows, by pressing the key when the measurement value screen appears:  $L_vxy \rightarrow L_vu'v' \rightarrow L_vT\Delta uv \rightarrow XYZ \rightarrow$  Dominant wavelength/Excitation purity  $\rightarrow$  Spectral graph  $\rightarrow L_vxy$ . (p.39)
- (4) **ESC key**                    If this key is pressed when the MENU screen is displayed, the settings are canceled and the measurement value screen appears again. If pressed during numerical input or when making each setting, the settings are canceled. If pressed during continuous measurement, the measurement ends.
- (5) **BACKLIGHT key**                    Selects backlight ON/OFF on LCD screen. (p.49)
- (6) **MEMORY key**                    Measured data is stored in memory by pressing this key when the measurement value screen appears. (p.57)
- (7) **▲ ▼ keys**                    Memory data, target color channels, calibration channels, etc., are changed by pressing the key when the screen for display of various data appears. The cursor position is moved up and down, or the values and set items are changed, by pressing the key during numerical input or when making each setting.
- ◀ ▶ keys**                    The cursor position moves right and left by pressing the key for numerical input or when making each setting.
- ENTER key**                    Press the key to fix the contents selected in ▲ ▼ ▶ ◀ .



---

## Diopter Adjustment

Rotate the diopter adjustment ring for adjustment of diopter.

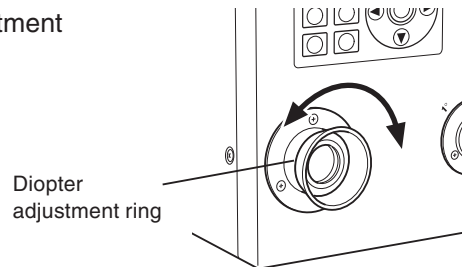

Adjust so that A or B on aperture or black circle indicating measuring area looks clear when observing object through finder.

Adjustment would be easy starting with 1° aperture where object near aperture looks blur.

Make sure to adjust diopter before measurement. Diopter should be adjusted for the eyesight of the person who will be taking measurement. If diopter is not adjusted before focus measurement, correct measurement value may not be expected. This is because the focus is actually off even if you think it is correctly in focus. In addition, if diopter is not correctly adjusted, you may see the aperture moving depending on viewing angle.

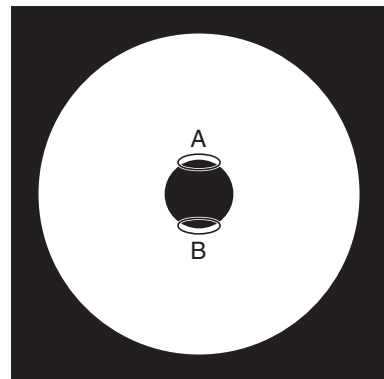

\* You sometimes see small black dots or stripes in internal finder. It gives no effect on measuring performance.

# LCD Screen

## MEAS (Measurement value) screen

“SNGL” is displayed for the values obtained during single measurement, while “CONT” is displayed for the values obtained during continuous measurement. (p.55)

Calibration channel (p.47) Target color channel (p.63, 67, 69)

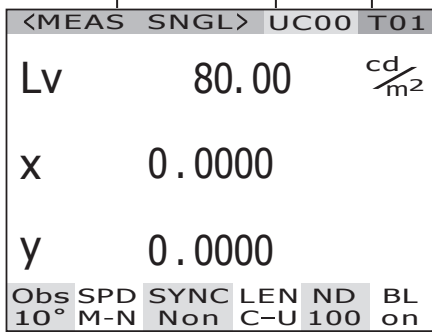

Measurement result is displayed in the currently selected color space. ( $L_vxy$ ,  $L_vu'v'$ ,  $L_vT\Delta uv$ , XYZ, Dominant wavelength/Excitation purity, Spectral graph) (p.39)  
Display format can be changed. (p.37)

Setting status in this instrument is displayed.

### <Obs>

Currently selected observer angle is displayed. (2°,10°) (p.35)

### <SPD>

Currently selected measuring time is displayed. (Nrm, Fst, M-N, M-F, Mnl) (p.29)

### <SYNC>

“Int” is displayed when the internal sync measurement mode is set. “Ext” is displayed when the external sync measurement mode. “Non” is displayed when the sync measurement mode is not set. (p.26)

---

## MENU screen

The MENU screen appears if MENU key is pressed when the measurement value screen is displayed.

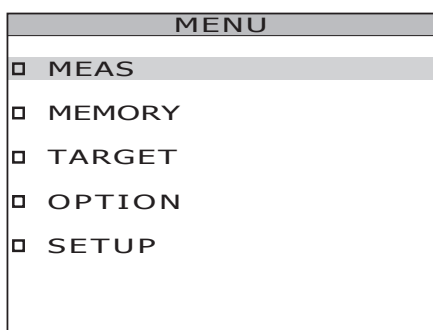

**MEAS**

Used to set measurement time or synchronizing method. (p.26, 30)

**MEMORY**

Used to read or delete the measurement memory data. (p.57, 60)

**TARGET**

Used to register, select or delete the target color. (p.63, 67, 69)

**OPTION**

Used to set the closeup lens, ND filter or calibration channel. (p.43, 45, 47)

**SETUP**

Used to set the observer, backlight, display format, and communication settings. (35, 49, 37, 51)

**<LENS>**

“C-U” is displayed, if the closeup lens is attached. If not, “Std” is displayed (p.43).

**<ND>**

The current ND filter type is displayed. (Non, 10, 100) (p.45)

**<BL>**

“On” is displayed, if the backlight is set to be turned on during the measurement. “Off” is displayed, if the backlight is set to be turned off during that time. (p.49)



# Installation

# Installing

Use screw holes for fixing at the bottom of this instrument if utilized with the tripod or jig. 2-type holes are available.

**Tripod screw hole:** To set on the tripod. Use a tripod screw with top diameter of 3/8 inches and depth of 10.5 mm.

[Note] The tripod screw holes correspond with the 3/8-inch screws of a large camera tripod. 1/4-inch screws cannot be used for fixing this instrument.

**ISO screw hole:** To set on the jig. Use ISO screws with top diameter of 5 mm and depth of 6.5 mm.

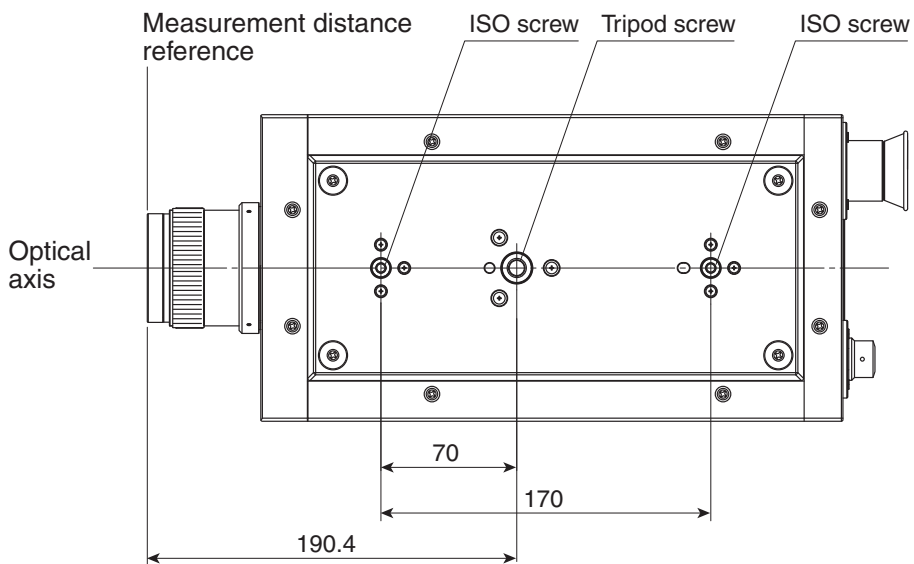







For other detailed dimensions, see p.82.

# Connecting AC Adapter

The AC adapter supplied with this instrument is used for the corresponding power source.

## **Warning** (Failure to adhere to the following points may result in death or serious injury.)

-  Always use the AC adapter and power cord supplied as a standard accessory or optional accessory (AC-A312), and connect it to indoor AC outlet of rated voltage and frequency (100 - 120 V  $\sim$  or 200 - 240 V  $\sim$  , 50/60Hz). Failure to follow either of these may result in damage to unit, fire or electric shock.
-  If this instrument is not used for a long time, disconnect AC adapter from AC outlet. Accumulated dirt or water on prongs of AC adapter plug may cause fire and should be removed before use.
-  Do not forcibly pull any part on power cord when unplugging since this may cause fire or electric shock. Gently disconnect by holding plug. Also, do not handle power cord with wet hands. Doing so may cause electric shock.
-  Do not forcibly bend, twist or pull power cord. Also, do not place heavy object on power cord, or damage or modify one. Any of these may cause fire or electric shock due to damage to power cord.
-  Do not disassemble or modify this instrument or AC adapter. Doing so may cause fire or electric shock.
-  Should this instrument or AC adapter be damaged or smoke or odd smell be generated, do not keep using such instrument or AC adapter without correction. Doing so may cause fire. In such situations, switch power off immediately, unplug AC adapter and contact the nearest KONICA MINOLTA authorized service facility.

## **Caution** (Failure to adhere to following points may result in injury or damage to this instrument or other property.)

-  Use this instrument near AC outlet for easy plugging or unplugging in using AC adapter.

## Connection Method

- 1.** Make sure that power switch is OFF (slided to [O] side).

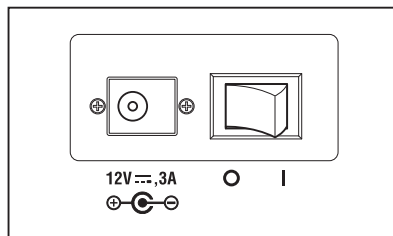

- 2.** Connect the AC adapter plug to the AC adapter input terminal of the body.

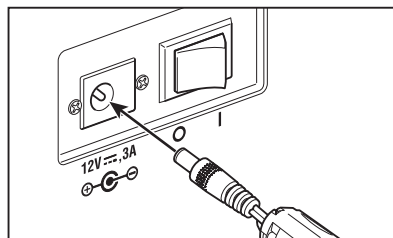

- 3.** Plug the AC adapter to outlet (100 - 120 VAC ~ or 200 - 240 VAC ~ , 50 Hz/60 Hz).

Insert the AC adapter plug all the way seated in AC outlet.



# Power Switch ON ( | )/OFF(O)

The warm-up time needed is a minimum of 20 minutes in order to measure the objects with excellent accuracy under the conditions described below. Warm up this instrument for 20 or more minutes when the power source is turned off even for a short period, and turned on again.

- (1) The object is a low-luminance light source, using 2856 K (standard light source A) as a guide:
- 2 cd/m<sup>2</sup> or lower (1° Aperture)
  - 50 cd/m<sup>2</sup> or lower (0.2° Aperture)
  - 200 cd/m<sup>2</sup> or lower (0.1° Aperture)
- (2) Outside room temperature and normal humidity ranges

## Turning power switch ON

### 1. Slide power switch to ON ( | ) side.

- ◆ The measurement screen appears 5 seconds after the initial screen on the LCD.
- ◆ The model type (CS-2000 or CS-2000A), body version and product serial numbers are displayed on the initial screen. The model type can be also confirmed on the nameplate.

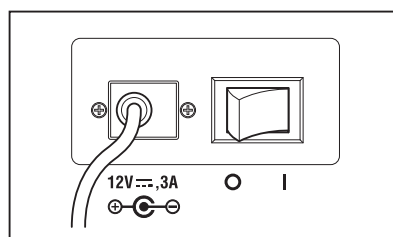

## Turning power switch OFF

### 2. Slide power switch to OFF (O side) after measurement.

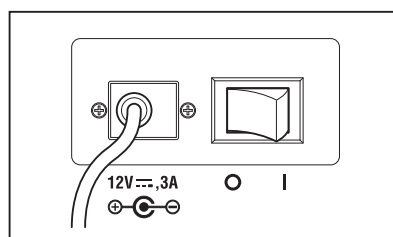



# Setting

# Setting of Synchronization

The synchronized measurement refers to measurement mode where measurement is made in the same timing as periodical light source pulse frequency, such as vertically synchronized frequency for the display device.

## [INT SYNC]

The internal sync measurement mode is used to measure the display equipment without the input of vertically synchronized signals to the body, or to measure flicker light from a light source such as a fluorescent light. Input the frequency of vertically synchronized signals for the display equipment, or the commercial frequency (50 or 60 Hz) for flicker light from a light source such as a luminescent light. The optimal integration time is automatically set based on the input value and the brightness of the object. For this reason, enter the correct frequency value to two places of decimals. However, if the vertically synchronized frequency of the display equipment is not clear, accurate measurement will not be possible with an inaccurate frequency setting. In this case it is recommended to select [NO SYNC] mode without sync measurement (at 60 Hz of frequency), but to select [MULTI-NORMAL] mode or [MULTI-FAST] mode for the measurement time (refer to p.29).

## [EXT SYNC]

The external sync measurement mode is used to measure the display equipment after the line input of a vertically synchronized signal through the input terminal for vertically synchronized signals to the body. The optimal integration time is set automatically, based on the frequency of vertically synchronized signals and the brightness of the object. Input CMOS (5V) Level of the input signals.

\* Range of synchronized frequencies : 20.00 to 200.00 Hz

\* Factory default setting : NO SYNC

## Operation Procedure

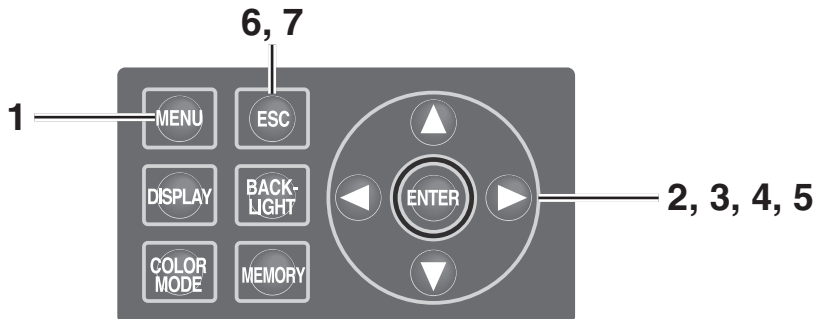

### 1. Press **MENU** key when the MEAS screen is displayed.

The **MENU** screen appears.

When the backlight of the LCD has been turned off via **BACKLIGHT** key on the MEAS screen, the backlight is turned on.

<MEAS SNGL>		UC00	T01
Lv	35.93		$\frac{cd}{m^2}$
X	0.3968		
Y	0.4060		
Obs	SPD	SYNC	LEN ND
2°	Nrm	Non	StdNon
			BL on



MENU	
<input type="checkbox"/>	MEAS
<input type="checkbox"/>	MEMORY
<input type="checkbox"/>	TARGET
<input type="checkbox"/>	OPTION
<input type="checkbox"/>	SETUP

2. Press either  or  key to select [MEAS] and then press **ENTER** key.

The MENU – MEAS screen appears.

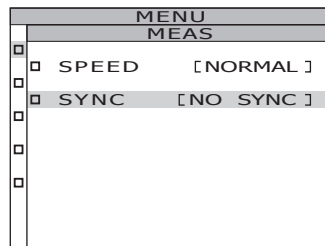
The current set contents are displayed in the SYNC item.



3. Press either  or  key to select [SYNC] and then press **ENTER** key.

The MENU - MEAS - SYNC MODE (sync method selection) screen appears.

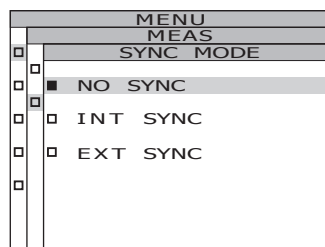

4. Press either  or  key to select the sync method.

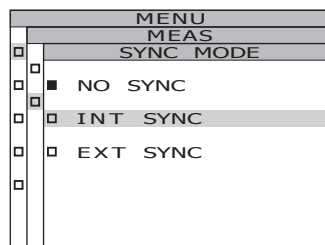

- 4-a-1. INT SYNC setting:  
Select [INT SYNC] and press **ENTER** key.

The MENU - MEAS - SYNC MODE – INT SYNC screen appears. This screen is used for the input of an internal synchronized frequency.

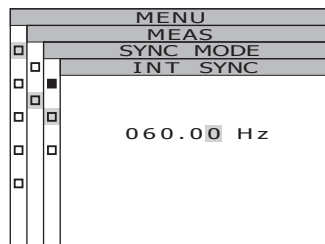

- 4-a-2. Press either  or  key to set a value.

 key for larger number.

 key for smaller number.

The range of the internal synchronized frequency is from 20 Hz to 200 Hz.

- 4-a-3. Press either  or  key to move the cursor.

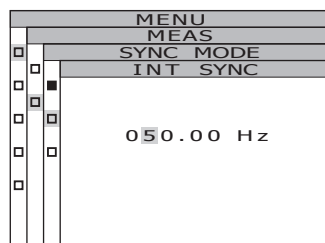

#### 4-a-4. Repeat the same procedures 4-a-2. and -3. as necessary.

#### 4-a-5. Press **ENTER** key.

After the setting is entered, the **MENU - MEAS - SYNC MODE** screen appears again on the LCD.

#### 5. Press **ENTER** key.

When the synchronizing method is set, the **MENU - MEAS** screen appears again on the LCD.

By pressing **ESC** key, after the setting is canceled the **MENU - MEAS** screen appears again on the LCD.

The setting of the synchronizing method is saved even after the power switch is turned off (O).

#### 6. Press **ENTER** key.

The **MENU** screen appears again on the LCD.

#### 7. Press **ESC** key.

The **MEAS** screen appears again on the LCD.

<MEAS SINGL> UC00 T01			
Lv	35.93		cd/m <sup>2</sup>
X	0.3968		
Y	0.4060		
Obs	SPD	SYNC	LEN ND BL
2°	Nrm	Int	StdNon on



# Selecting Measurement Time

Select measurement time according to the purpose. Five modes are available for measurement time.

Measurement time mode	Operation explanation	Feature	Cautions	Examples of measurement subjects
NORMAL	In this mode, integration time <sup>*1</sup> is adjusted between 0.005s and 120s according to the brightness of the measurement subject. This mode emphasizes performance when measuring low luminances.	Improved accuracy and repeatability for luminances below approx. 4 cd/m <sup>2</sup> (measurement angle: 1°)	When measuring low luminances, since the total measurement time can be as long as 4 minutes, if the brightness of the measurement subject changes, the measurement results will be the average luminance. In addition, be careful to not move the instrument during measurement. When measuring periodic light sources, MULTI INTEG-NORMAL mode or MULTI INTEG-FAST mode may be more suitable, for example, when the synchronization frequency is unknown.	Constant light sources (halogen lamps, etc.)  Periodic light sources (whose are stable and whose synchronization frequency is known)
FAST	In this mode, integration time is adjusted between 0.005s and 16s according to the brightness of the measurement subject. This mode emphasizes measurement time when measuring low luminances.	Shorter measuring times for luminances below approx. 4 cd/m <sup>2</sup> (measurement angle: 1°)	When higher accuracy and repeatability are required at low luminances, the NORMAL mode should be used if necessary.	Same as above
MULTI INTEG-NORMAL	In this mode, several cycles of the integration time for NORMAL mode are taken and averaged. Under luminance conditions which require an integration time longer than the set luminance, the integration time will be the same as for normal measurement. This mode can be used when the synchronization time for measurement is unknown or when the synchronization time is known but the frequency is unstable. In such case, the sync mode should be set to NO SYNC.	Measurements which do not depend on the synchronization frequency of the measurement subject can be taken. Improved accuracy and repeatability for luminances below approx. 4 cd/m <sup>2</sup> (measurement angle: 1°)	Even for high luminances, the set integration time (1s or longer) will be used.	Periodic light sources (whose synchronization frequency is unknown or unstable)
MULTI INTEG-FAST	In this mode, several cycles of the integration time for FAST mode are taken and averaged. Under luminance conditions which require an integration time longer than the set luminance, the integration time will be the same as for FAST measurement. This mode can be used when the synchronization time for measurement is unknown or when the synchronization time is known but the frequency is unstable. In such case, the sync mode should be set to NO SYNC.	Measurements which do not depend on the synchronization frequency of the measurement subject can be taken. Shorter measuring times for luminances below approx. 4 cd/m <sup>2</sup> (measurement angle: 1°)	Even for high luminances, the set integration time (1s or longer) will be used	Periodic light sources (whose synchronization frequency is unknown or unstable)
MANUAL	This mode can be used when you want to set a fixed integration time for measurements. Integration time: 0.005s to 120s	The desired fixed integration time can be set.	Be careful that the "OVER" error message does not occur and that the measurement accuracy is not reduced.	All light sources

\*1 Time for sensor to measure light indicating "exposure time". On the other hand, measurement time shows time for integration × 2 + Time to open/close shutter + Time for calculation), indicating time needed for actual measurement.

\* Factory default setting : MULTI INTEG-NORMAL, IN-ND : AUTO

## Operation Procedure

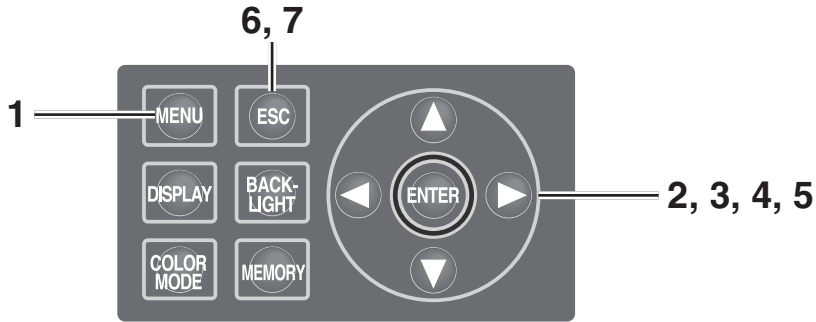

1. Press **MENU** key when the MEAS screen is displayed.

The **MENU** screen appears.

When the backlight of the LCD has been turned off via **BACKLIGHT** key on the MEAS screen, the backlight is turned on.

<MEAS SNGL> UC00 T01		
LV	35.85	$\frac{cd}{m^2}$
X	0.3964	
Y	0.4059	
Obs	SPD	SYNC LEN ND BL
2°	Nrm	Non StdNon on

MENU	
<input type="checkbox"/>	MEAS
<input type="checkbox"/>	MEMORY
<input type="checkbox"/>	TARGET
<input type="checkbox"/>	OPTION
<input type="checkbox"/>	SETUP

2. Press either **▲** or **▼** key to select **[MEAS]** and then press **ENTER** key.

The **MENU – MEAS** screen appears.

The current set contents are displayed in the **SPEED** item.

MENU	
MEAS	
<input type="checkbox"/>	<b>SPEED [NORMAL]</b>
<input type="checkbox"/>	SYNC [NO SYNC]
<input type="checkbox"/>	
<input type="checkbox"/>	

3. Press either **▲** or **▼** key to select **[SPEED]** and then press **ENTER** key.

The **MENU - MEAS - SPEED MODE** (measurement speed setting) screen appears.

MENU	
MEAS	
SPEED MODE	
<input checked="" type="checkbox"/>	<b>NORMAL</b>
<input type="checkbox"/>	FAST
<input type="checkbox"/>	MULTI-NORMAL
<input type="checkbox"/>	MULTI-FAST
<input type="checkbox"/>	MANUAL



4. Press either  or  key to select measurement speed.

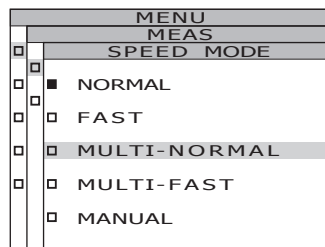

- 4-a-1. **NORMAL or FAST setting:** Select [NORMAL] or [FAST] and press **ENTER** key.

The MENU - MEAS - SPEED MODE - IN-ND screen appears.

This screen is used to determine whether the ND filter built into the body is used or not.

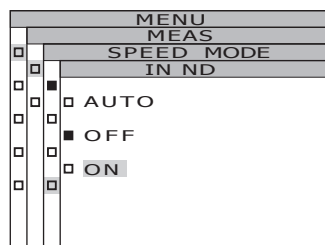

- 4-a-2. Press either  or  key to select [AUTO], [OFF] or [ON].

Select [ON] when the error message "OVER" appears.

When measuring objects having a wide range of luminance under the adjusted measurement conditions (ex.  $\gamma$  measurement), set IN-ND to [OFF] or [ON]. For [OFF] or [ON] selection, select [OFF] when the upper limit luminance is 100cd/m<sup>2</sup> or less, and [ON] when it is 100cd/m<sup>2</sup> or more as a guide.

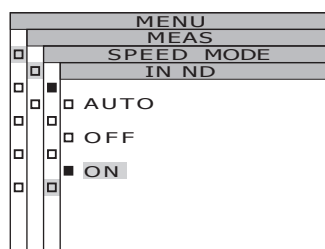

- 4-a-3. Press **ENTER** key.

After the setting is entered, the MENU - MEAS - SPEED MODE screen appears again on the LCD.

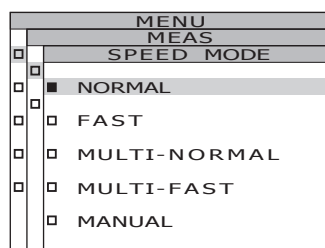

- 4-b-1. **MULTI-NORMAL or MULTI-FAST setting:** Select [MULTI-NORMAL] or [MULTI-FAST] and press **ENTER** key.

The MENU - MEAS - SPEED MODE - MULTI INTEG screen appears.

This screen is used for input of the integration time in the MULTI INTEG-NORMAL mode or MULTI INTEG-FAST mode.

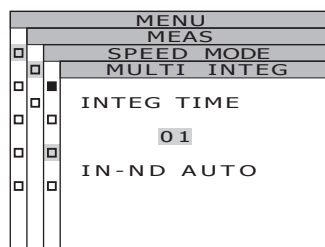

#### 4-b-2. Press either or key to set a value.

 key for larger number.

 key for smaller number.

The setting range of integration time is from 1 to 16 s.

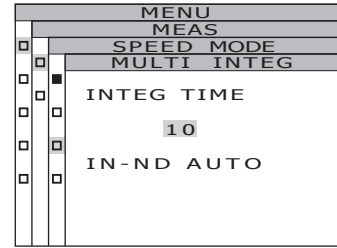

#### 4-b-3. Press **ENTER** key. The cursor moves to the IN-ND item.

This screen is used to determine whether the ND filter built into the body is used or not.

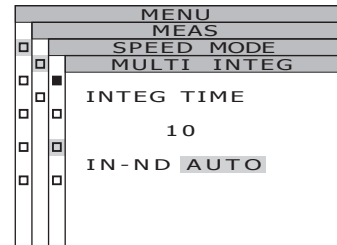

#### 4-b-4. Press either or key to select [AUTO], [OFF] or [ON].

Select [ON] when the error message "OVER" appears.

When measuring objects having a wide range of luminance under the adjusted measurement conditions (ex.  $\gamma$  measurement), set IN-ND to [OFF] or [ON]. For [OFF] or [ON] selection, select [OFF] when the upper limit luminance is 100cd/m<sup>2</sup> or less, and [ON] when it is 100cd/m<sup>2</sup> or more as a guide.

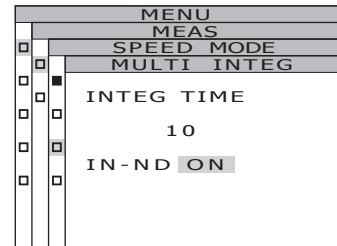

#### 4-b-5. Press **ENTER** key.

After the setting is entered, the **MENU - MEAS - SPEED MODE** screen appears again on the LCD.

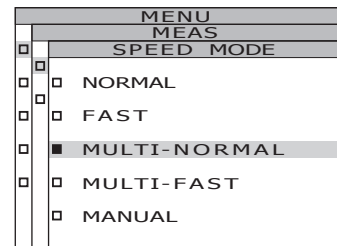

#### 4-c-1. MANUAL setting: Select [MANUAL] and press **ENTER** key.

The **MENU - MEAS - SPEED MODE - MANUAL** screen appears. This screen is used for input of the integration time in the manual mode.

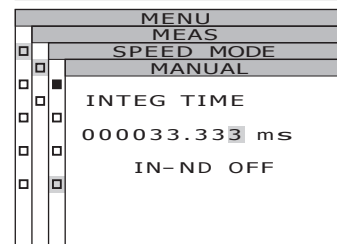
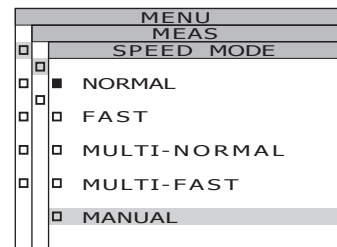

#### 4-c-2. Press either or key to set a value.

 key for larger number.

 key for smaller number.

The setting range of integration time is from 5 to 120,000 ms.

The significant figures for integration time are 6 digits.

Moreover, the actual integration time when the integration time is 4 s or more is an integral multiple of 4 s.

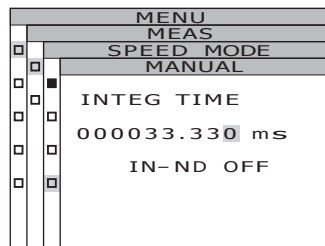

#### 4-c-3. Press either or key to move the cursor.

#### 4-c-4. Repeat the same procedures 4-a-2. and -3. as necessary.

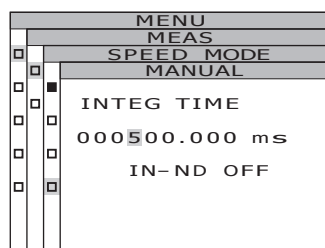

#### 4-c-5. Press **ENTER** key.

The cursor moves to the IN-ND item.

This screen is used to determine whether the ND filter built into the body is used or not.

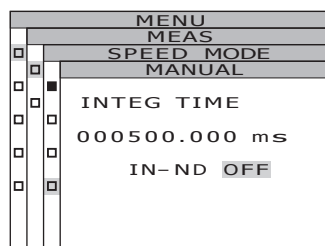

#### 4-c-6. Press either or key to select [ON] or [OFF].

Select [ON] when the error message "OVER" appears.

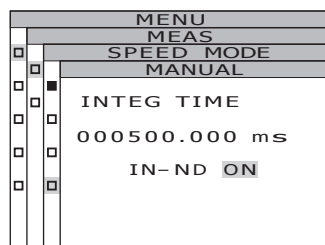

#### 4-c-7. Press **ENTER** key.

When the setting is entered, the **MENU - MEAS - SPEED MODE** screen appears again on the LCD.

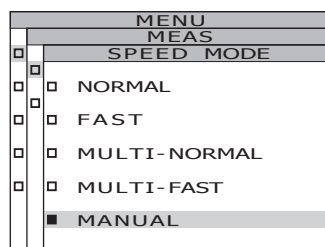

**5. Press ENTER key.**

When the measurement time is set, the **MENU - MEAS screen** appears again on the LCD.

By pressing ESC key, after the setting is canceled the **MENU - MEAS screen** appears again on the LCD.

Measurement time setting is saved even after switching OFF (O).

**6. Press ESC key.**

The **MENU screen** appears again on the LCD.

**7. Press ESC key.**

The **MEAS screen** appears again on the LCD.

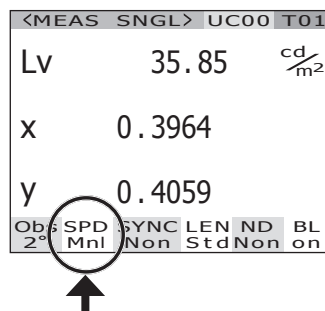

# Setting Observer

Color matching function for chromaticity calculation is selectable between 2°OBS and 10°OBS.

\* Observer setting : 2° OBS, 10° OBS

\* Factory default setting : 2° OBS

## Operation Procedure

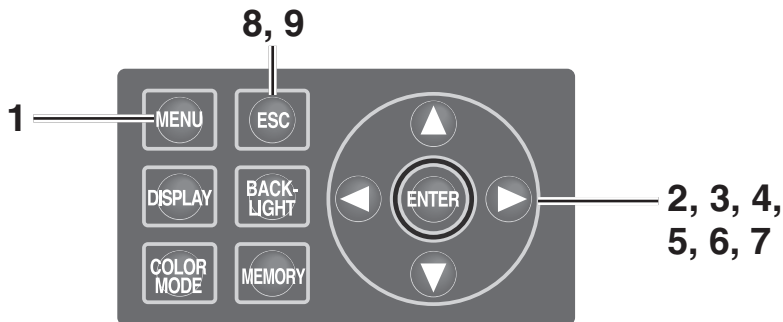

1. Press **MENU** key when the MEAS screen is displayed.

The **MENU** screen appears.

When the backlight of the LCD has been turned off via **BACKLIGHT** key on the MEAS screen, the backlight is turned on.

<MEAS	SNGL>	UC00	T01
LV	35.85		cd/m <sup>2</sup>
X	0.3964		
Y	0.4059		
Obs	SPD	SYNC	LEN ND BL
2°	Mnl	Non	StdNon on

MENU	
<input type="checkbox"/>	MEAS
<input type="checkbox"/>	MEMORY
<input type="checkbox"/>	TARGET
<input type="checkbox"/>	OPTION
<input type="checkbox"/>	SETUP

2. Press either **▲** or **▼** key to select **[SETUP]** and then press **ENTER** key.

The **MENU – SETUP** screen appears.

The current set contents are displayed in the **[OBSERVER]** item.

MENU		SETUP	
<input type="checkbox"/>	OBSERVER	[ 2° ]	
<input type="checkbox"/>	BACKLIGHT@MEAS	[ ON ]	
<input type="checkbox"/>	DATA FORM	[ F ]	
<input type="checkbox"/>	RS-232C BAUDRATE	[ 115200bps ]	

3. Press either **▲** or **▼** key to select **[OBSERVER]** and then press **ENTER** key.

The **MENU - SETUP – OBSERVER (Observer selection)** screen appears.

MENU		SETUP		OBSERVER	
<input type="checkbox"/>		<input checked="" type="checkbox"/>	2° OBS		
<input type="checkbox"/>		<input type="checkbox"/>	10° OBS		

4. Press either  $\blacktriangle$  or  $\blacktriangledown$  key to select [2° OBS] or [10° OBS].

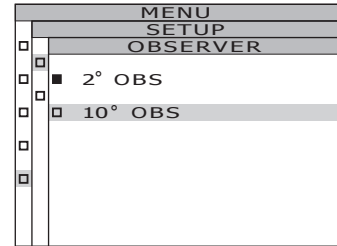

5. Press **ENTER** key.  
The confirmation screen appears. **CANCEL** is selected.

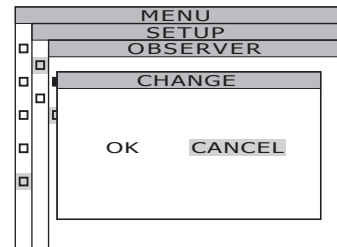

6. Press  $\blacktriangleleft$  key to move the cursor to **OK**.

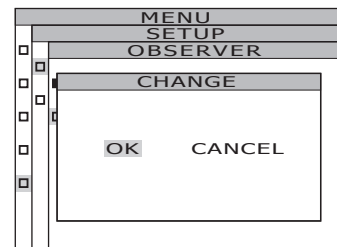

7. Press **ENTER** key.  
When the observer angle is set, the **MENU - MEAS** screen appears again on the LCD.  
By pressing **ESC** key, after the setting is canceled the **MENU - SETUP** screen appears again on the LCD.  
Observer setting is saved even after switching OFF (O).

8. Press **ESC** key.  
The **MENU** screen appears again on the LCD.

9. Press **ESC** key.  
The **MEAS** screen appears again on the LCD.  
When observer angle is set to 10°,  $L_v$  display changes to Y display.

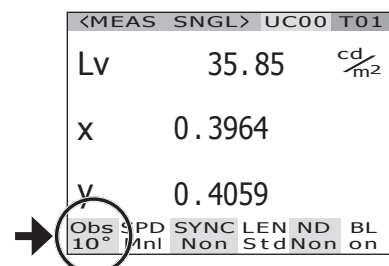

# Selecting Display Format

The formats of indicating the luminance and excitation values X, Y and Z can be selected as either normal indication to display the values to four places of decimals, or as index number indication. If the measurement values on the LCD are unreadable, use the index number indication.

\* Display format setting : Normal, Index

\* Factory default setting : \*\*\*\*.\*\*\*\* [F]

\* When the number of displayed digits is six (luminance and X/Y/Z are 100000 or more) in the normal indication, "\*\*\*\*\*.\*\*\*\*\*" will be displayed. In this case, the value will be displayed if you set to the index number indication.

## Operation Procedure

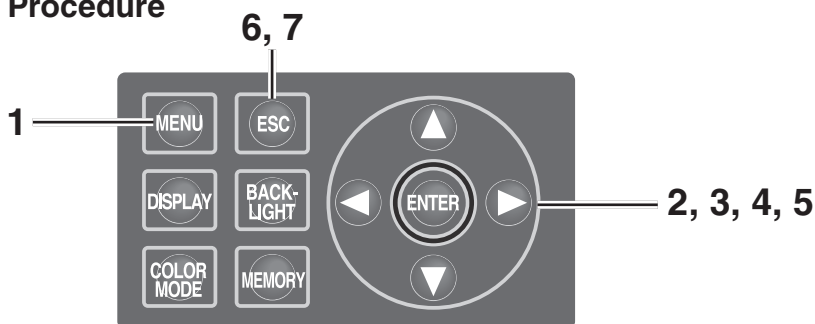

1. Press **[MENU]** key when the MEAS screen is displayed.

The **MENU** screen appears.

When the backlight of the LCD has been turned off via **[BACKLIGHT]** key on the MEAS screen, the backlight is turned on.

<MEAS SNGL> UC00 T01			
LV	35.85	cd/m <sup>2</sup>	
X	0.3964		
Y	0.4059		
Obs 2°	SPD Mnl	SYNC Non	LEN ND Std
			BL Non on

MENU	
<input type="checkbox"/>	MEAS
<input type="checkbox"/>	MEMORY
<input type="checkbox"/>	TARGET
<input type="checkbox"/>	OPTION
<input checked="" type="checkbox"/>	SETUP

2. Press either **▲** or **▼** key to select **[SETUP]** and then press **[ENTER]** key.

The **MENU - SETUP** screen appears.

The current set contents are displayed in the **[DATA FORM]** item.

MENU SETUP	
<input type="checkbox"/>	OBSERVER [2°]
<input type="checkbox"/>	BACKLIGHT@MEAS [ON]
<input checked="" type="checkbox"/>	DATA FORM [F]
<input type="checkbox"/>	RS-232C BAUDRATE [115200bps]

3. Press either **▲** or **▼** key to select **[DATA FORM]** and then press **[ENTER]** key.

The **MENU - SETUP - DATA FORM (Display format selection)** screen appears.

MENU SETUP DATA FORM	
<input checked="" type="checkbox"/>	****.****
<input type="checkbox"/>	*.****E+*

4. Press either  $\blacktriangle$  or  $\blacktriangledown$  key to select [\*\*\*\*.\*\*\*\* [F]] or [\*.\*.\*.\*E+\* [E]].

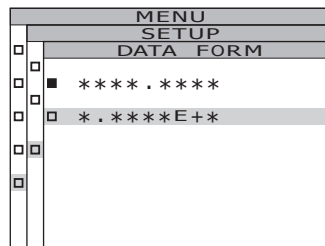

5. Press **ENTER** key.
- When the display format is set, the **MENU - SETUP** screen appears again on the LCD. By pressing **ESC** key, after the setting is canceled the **MENU - SETUP** screen appears again on the LCD. Display format setting is saved even after switching OFF (O).

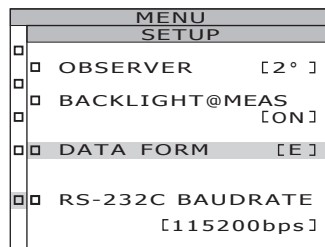

6. Press **ESC** key.
- The **MENU** screen appears again on the LCD.

7. Press **ESC** key.
- The **MEAS** screen appears again on the LCD.

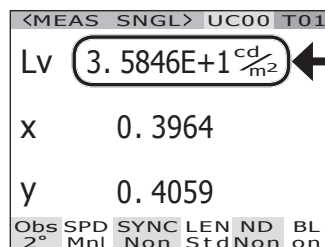



# Selecting Color Space

See below table for available color space.

\* Factory default setting :L<sub>v</sub>xy

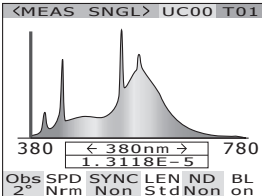
Color Space	LCD Screen		Display Description
	(When Normal is selected for display format)	(When Index is selected for display format)	
L <sub>v</sub> xy *1	<pre> &lt;MEAS SNGL&gt; UC00 T01 Lv      34.22  cd/m² x       0.3958 y       0.4060 Obs SPD SYNC LEN ND BL 2°  Nrm  Non  StdNon on                     </pre>	<pre> &lt;MEAS SNGL&gt; UC00 T01 Lv  3.4221E+1  cd/m² x   0.3958 y   0.4060 Obs SPD SYNC LEN ND BL 2°  Nrm  Non  StdNon on                     </pre>	Displays and outputs in luminance L <sub>v</sub> and chromaticity coordinates x,y.
L <sub>v</sub> u'v' *1	<pre> &lt;MEAS SNGL&gt; UC00 T01 Lv      34.22  cd/m² u'      0.2236 v'      0.5161 Obs SPD SYNC LEN ND BL 2°  Nrm  Non  StdNon on                     </pre>	<pre> &lt;MEAS SNGL&gt; UC00 T01 Lv  3.4221E+1  cd/m² u'   0.2236 v'   0.5161 Obs SPD SYNC LEN ND BL 2°  Nrm  Non  StdNon on                     </pre>	Displays and outputs in luminance L <sub>v</sub> and u'v' chromaticity diagram (CIE 1976 UCS chromaticity diagram) coordinates u', v'.
L <sub>v</sub> T Δuv	<pre> &lt;MEAS SNGL&gt; UC00 T01 Lv      34.22  cd/m² T       3829K duv     +0.009 Obs SPD SYNC LEN ND BL 2°  Nrm  Non  StdNon on                     </pre>	<pre> &lt;MEAS SNGL&gt; UC00 T01 Lv  3.4221E+1  cd/m² T   3829K duv  +0.009 Obs SPD SYNC LEN ND BL 2°  Nrm  Non  StdNon on                     </pre>	Displays and outputs in luminance L <sub>v</sub> , correlated color temperature T and color difference from blackbody locus Δuv.
XYZ	<pre> &lt;MEAS SNGL&gt; UC00 T01 X       33.36 Y       34.22 Z       16.71 Obs SPD SYNC LEN ND BL 2°  Nrm  Non  StdNon on                     </pre>	<pre> &lt;MEAS SNGL&gt; UC00 T01 X   3.3365E+1 Y   3.4221E+1 Z   1.6709E+1 Obs SPD SYNC LEN ND BL 2°  Nrm  Non  StdNon on                     </pre>	Displays and outputs in tristimulus values X, Y, Z.
Dominant wavelength/ Excitation purity *2	<pre> &lt;MEAS SNGL&gt; UC00 T01 λd  +576.220nm Pe   0.407% Obs SPD SYNC LEN ND BL 2°  Nrm  Non  StdNon on                     </pre>		Displays and outputs in dominant wavelength λ <sub>d</sub> and excitation purity P <sub>e</sub> .
Spectral graph	<pre> &lt;MEAS SNGL&gt; UC00 T01  380  &lt; 380nm &gt; 780       1.3118E-5 Obs SPD SYNC LEN ND BL 2°  Nrm  Non  StdNon on                     </pre>		Displays or outputs spectral radiance L <sub>e</sub> (λ) in the spectral waveform

- \*1 Y is displayed instead of  $L_v$  when observer angle is  $10^\circ$ .
- \*2 For non-spectral colors, the complementary wavelength will be displayed. The display indication will remain  $\lambda_d$ .
- \* If the calculated value does not establish a proper combination with the value in the color space mode, “\_ \_ \_ \_ \_” will be displayed.

## Operation Procedure

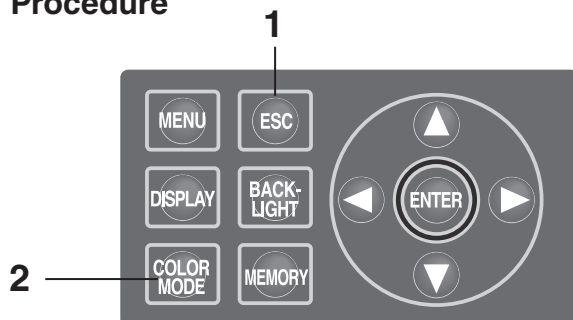

1. When the MENU or MEMORY screen is displayed, press **ESC** key to switch to the MEAS screen.

<MEAS	SNGL>	UC00	T01
Lv	34.22		$\frac{cd}{m^2}$
x	0.3958		
y	0.4060		
Obs	SPD	SYNC	LEN ND BL
2°	Nrm	Non	StdNon on

2. Press **COLOR MODE** key to display the desired color space.

Measurement screen switches in order of  $L_vxy$  →  $L_vu'v'$  →  $L_vT\Delta uv$  → XYZ →  $\lambda_d/Pe$  → Spectral graph →  $L_vxy$  while **COLOR MODE** key is pressed.

It switches in order of  $Yxy$  →  $Yu'v'$  → XYZ →  $\lambda_d/Pe$  → Spectral graph →  $Yxy$  when observer angle is  $10^\circ$ .

Color space setting is saved even after switching OFF (O).

<MEAS	SNGL>	UC00	T01
Lv	34.22		$\frac{cd}{m^2}$
u'	0.2236		
v'	0.5161		
Obs	SPD	SYNC	LEN ND BL
2°	Nrm	Non	StdNon on

# Selecting Absolute Value (ABS)/Difference (DIFF) Display

Whether chromaticity value is shown in absolute (ABS) or difference (DIFF) is selectable. See below table for each case.

\* Factory default setting: Absolute value (ABS)

Color Space	Absolute value (ABS)	Difference (DIFF)
$L_v, xy$ *1	$L_v, x, y$ <pre> &lt;MEAS SNGL&gt; UC00 T01 Lv      34.22  cd/m² x       0.3958 y       0.4060 Obs SPD SYNC LEN ND BL 2° Nrm Non StdNon on                     </pre>	$L_v, x, y$ $\Delta L_v, \%L_v, \Delta x, \Delta y$ <pre> &lt;MEAS SNGL&gt; UC00 T01 Lv      34.34  cd/m² x       0.3958 y       0.4059 ΔLv     +0.1188  cd/m² %Lv     100.35% Δx      -0.0000 Δy      -0.0001 Obs SPD SYNC LEN ND BL 2° Nrm Non StdNon on                     </pre>
$L_v, u'v'$ *1	$L_v, u', v'$ <pre> &lt;MEAS SNGL&gt; UC00 T01 Lv      34.22  cd/m² u'      0.2236 v'      0.5161 Obs SPD SYNC LEN ND BL 2° Nrm Non StdNon on                     </pre>	$L_v, u', v'$ $\%L_v, \Delta L_v, \Delta u', \Delta v'$ <pre> &lt;MEAS SNGL&gt; UC00 T01 Lv      34.34  cd/m² u'      0.2236 v'      0.5160 ΔLv     +0.1188  cd/m² %Lv     100.35% Δu'     +0.0000 Δv'     -0.0000 Obs SPD SYNC LEN ND BL 2° Nrm Non StdNon on                     </pre>
$L_v, T, \Delta uv$	$L_v, T, duv$ <pre> &lt;MEAS SNGL&gt; UC00 T01 Lv      34.22  cd/m² T       3829K duv     +0.009 Obs SPD SYNC LEN ND BL 2° Nrm Non StdNon on                     </pre>	$L_v, T, duv$ $\Delta L_v, \%L_v, \Delta T$ <pre> &lt;MEAS SNGL&gt; UC00 T01 Lv      34.34  cd/m² T       3830K duv     +0.009 ΔLv     +0.1188  cd/m² %Lv     100.35% ΔT      OK Obs SPD SYNC LEN ND BL 2° Nrm Non StdNon on                     </pre>
XYZ	$X, Y, Z$ <pre> &lt;MEAS SNGL&gt; UC00 T01 X       33.36 Y       34.22 Z       16.71 Obs SPD SYNC LEN ND BL 2° Nrm Non StdNon on                     </pre>	$X, Y, Z$ $\Delta X, \Delta Y, \Delta Z$ $\%X, \%Y, \%Z$ <pre> &lt;MEAS SNGL&gt; UC00 T01 X       33.49 Y       34.34 Z       16.78 ΔX      +0.1204 ΔY      +0.1188 ΔZ      +0.07479 ΔX%     100.36% ΔY%     100.35% ΔZ%     100.45% Obs SPD SYNC LEN ND BL 2° Nrm Non StdNon on                     </pre>
Dominant wavelength	$\lambda_d, P_e$ <pre> &lt;MEAS SNGL&gt; UC00 T01 λd     +576.220nm Pe     0.407% Obs SPD SYNC LEN ND BL 2° Nrm Non StdNon on                     </pre>	$\lambda_d \cdot P_e$ $\Delta \lambda_d, \Delta P_e$ *2 <pre> &lt;MEAS SNGL&gt; UC00 T01 λd     +576.220nm Pe     0.406 Δλd    -0.000nm ΔPe    -0.000% Obs SPD SYNC LEN ND BL 2° Nrm Non StdNon on                     </pre>

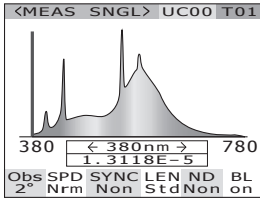
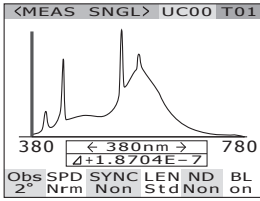
Color Space	Absolute value (ABS)	Difference (DIFF)
Spectral graph	<p><math>L_e(\lambda)</math> spectral waveform Wavelength at the cursor position and <math>L_e(\lambda)</math> in the wavelength</p> 	<p>Measurement value and <math>L_e(\lambda)</math> spectral waveform of target color Wavelength of the cursor position and <math>L_e(\lambda)</math> of the measurement value in the wavelength</p> 

\*1 Y is displayed instead of  $L_v$  when observer angle is  $10^\circ$ .

\*2 Even if either the measured value, target color, or both are the complementary wavelength, the difference between the two values will be displayed. The display indication will remain  $\Delta\lambda d$ .

\* If the calculated value or the registered target color does not establish a proper combination with the value in the color space mode, “\_ \_ \_ \_ \_” will be displayed.

## Operation Procedure

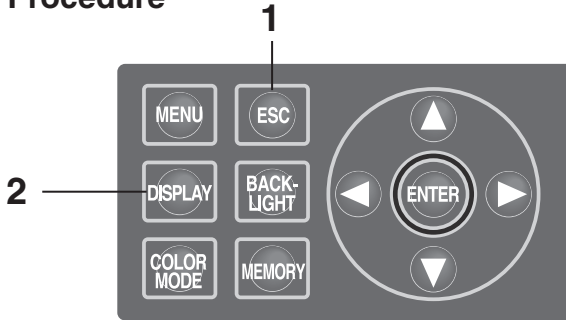

1. When the MENU or MEMORY screen is displayed, press **ESC** key to switch to the MEAS screen.

<MEAS SNGL> UC00 T01		
Lv	34.22	$\frac{cd}{m^2}$
x	0.3958	
y	0.4060	
Obs SPD SYNC LEN ND BL 2° Nrm Non StdNon on		

2. Press **DISPLAY** key to show absolute value (ABS) or color difference (DIFF) to select.

Measurement value switches between that for absolute value (ABS) and difference (DIFF) while **DISPLAY** key is pressed.

The setting of absolute value (ABS) and difference (DIFF) is saved even after switching OFF (O).

<MEAS SNGL> UC00 T01		
Lv	34.34	$\frac{cd}{m^2}$
x	0.3958	
y	0.4059	
$\Delta Lv$	+0.1188	$\frac{cd}{m^2}$
%Lv	100.35%	
$\Delta x$	-0.0000	
$\Delta y$	-0.0001	
Obs SPD SYNC LEN ND BL 2° Nrm Non StdNon on		

# When Using Closeup Lens

Use the closeup lens in the optional accessories to measure a fine surface. For the attachment of the closeup lens, refer to the instruction manual for the closeup lens. If the closeup lens is attached, the measurement value must be compensated for the lens transmittance. This compensation coefficient is attached to the closeup lens. Use the data management software CS-S10w Professional supplied with the CS-2000 as standard to set the coefficient in this instrument. After that, when the closeup lens is selected as lens type, the measurement value compensated with the compensation coefficient can be obtained. See instruction manual of CS-S10w for details.

The wrong setting of lens type leads to inaccurate measurement.

Do not use the closeup lens with the ND filter. It leads to inaccurate measurement.

\* Lens type : STANDARD, CLOSE-UP

\* Factory default setting : STANDARD

## Operation Procedure

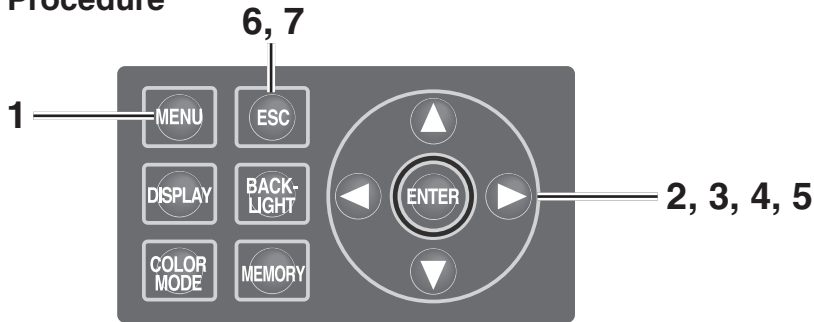

1. Press **MENU** key when the MEAS screen is displayed.

The **MENU** screen appears.

When the backlight of the LCD has been turned off via **BACKLIGHT** key on the MEAS screen, the backlight is turned on.

<MEAS SNGL>		UC00	T01
LV	35.93		$\frac{cd}{m^2}$
X	0.3968		
Y	0.4060		
Obs	SPD	SYNC	LEN ND
2°	Nrm	Int	StdNon
			BL on

MENU	
<input type="checkbox"/>	MEAS
<input type="checkbox"/>	MEMORY
<input type="checkbox"/>	TARGET
<input checked="" type="checkbox"/>	OPTION
<input type="checkbox"/>	SETUP

2. Press either **▲** or **▼** key to select **[OPTION]** and then press **ENTER** key.

The **MENU – OPTION** screen appears.

The current set contents are displayed in the **[LENS]** item.

MENU OPTION	
<input type="checkbox"/>	USER.CAL [NON]
<input checked="" type="checkbox"/>	LENS [STD]
<input type="checkbox"/>	ND-FILTER [NON]
<input type="checkbox"/>	
<input type="checkbox"/>	

3. Press either  $\blacktriangle$  or  $\blacktriangledown$  key to select [LENS] and then press  $\boxed{\text{ENTER}}$  key.

The MENU - OPTION – LENS (Lens type selection) screen appears.

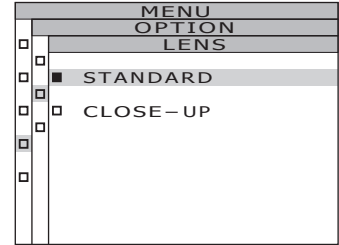

4. Press either  $\blacktriangle$  or  $\blacktriangledown$  key to select [CLOSE-UP].

When you removed the closeup lens, select [STANDARD].

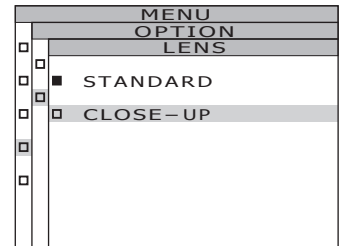

5. Press  $\boxed{\text{ENTER}}$  key.

When the lens type is set, the MENU - OPTION screen appears again on the LCD.

By pressing  $\boxed{\text{ESC}}$  key, after the setting is canceled the MENU - OPTION screen appears again on the LCD.

Lens type setting is saved even after switching OFF (O).

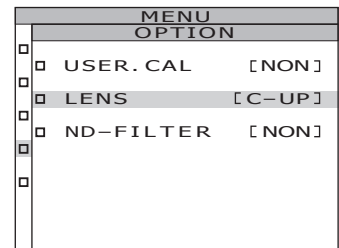

6. Press  $\boxed{\text{ESC}}$  key.

The MENU screen appears again on the LCD.

7. Press  $\boxed{\text{ESC}}$  key.

The MEAS screen appears again on the LCD.

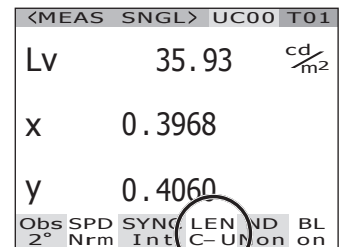

# When Using ND Filter

Use the ND filter in the optional accessories when measuring a high-luminance object.

If the ND filter is attached, the measurement value must be compensated for the filter transmittance. This compensation coefficient is attached to the ND filter. Use the data management software CS-S10w Professional supplied with the CS-2000 as standard to set the coefficient in this instrument. After that, when the ND filter is selected, the measurement value compensated with the compensation coefficient can be obtained. See instruction manual of CS-S10w for details.

The wrong setting of ND filter leads to inaccurate measurement.

Do not use the ND filter with the closeup lens. It leads to inaccurate measurement.

Note that an extra ND filter is built into this instrument. There are three setting options for use or non-use of this built-in ND filter: [AUTO] for switching automatically depending on the luminance of the object, [OFF] for constant non-use, and [ON] for constant use (See p.31 to p.33).

\* ND-FILTER : NONE, ND10, ND100

\* Factory default setting: NONE

## Operation Procedure

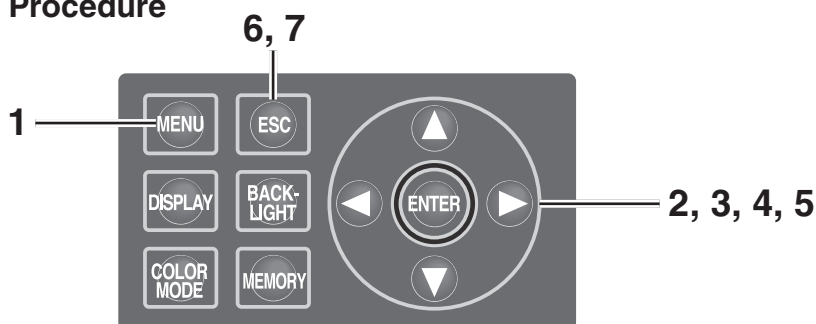

1. Press **MENU** key when the MEAS screen is displayed.

The **MENU** screen appears.

When the backlight of the LCD has been turned off via **BACKLIGHT** key on the MEAS screen, the backlight is turned on.

<MEAS SNGL> UC00 T01		
Lv	35.93	$\frac{cd}{m^2}$
X	0.3968	
Y	0.4060	
Obs 2°	SPD Nrm	SYNC Int
	LEN Std	ND Non
		BL on

MENU	
<input type="checkbox"/>	MEAS
<input type="checkbox"/>	MEMORY
<input type="checkbox"/>	TARGET
<input checked="" type="checkbox"/>	OPTION
<input type="checkbox"/>	SETUP

2. Press either **▲** or **▼** key to select **[OPTION]** and then press **ENTER** key.

The **MENU – OPTION** screen appears.

The current set contents are displayed in the **[ND-FILTER]** item.

MENU OPTION	
<input type="checkbox"/>	USER.CAL [NON]
<input type="checkbox"/>	LENS [STD]
<input checked="" type="checkbox"/>	ND-FILTER [NON]
<input type="checkbox"/>	

3. Press either  $\blacktriangle$  or  $\blacktriangledown$  key to select [ND-FILTER] and then press **ENTER** key.

The **MENU - OPTION – ND-FILTER (ND filter selection)** screen appears.

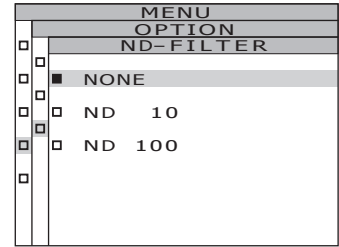

4. Press either  $\blacktriangle$  or  $\blacktriangledown$  key to select [NONE], [ND 10] or [ND 100].

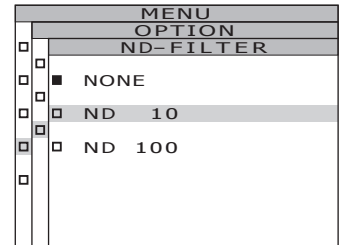

5. Press **ENTER** key.

When the ND filter is set, the **MENU - OPTION screen** appears again on the LCD.

By pressing **ESC** key, after the setting is canceled the **MENU - OPTION screen** appears again on the LCD.

ND filter setting is saved even after switching OFF (O).

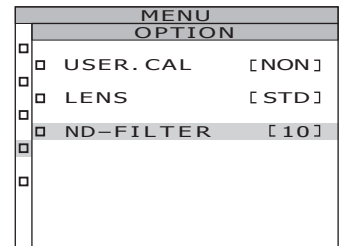

6. Press **ESC** key.

The **MENU screen** appears again on the LCD.

7. Press **ESC** key.

The **MEAS screen** appears again on the LCD.

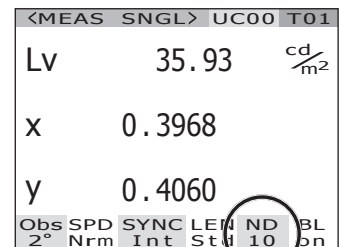



# Calibration

## Calibration Channel

This instrument includes 11 calibration channels from Ch00 to Ch10.

Ch00 is for measurement based upon KONICA MINOLTA's calibration standard. Its calibration correction coefficient has been set and is unchangeable.

The following contents can be set to Ch01 to Ch10 respectively using data management software CS-S10w Professional supplied with the CS-2000 as standard. See instruction manual of CS-S10w for details.

- Correction coefficient of user calibration
- Correction coefficient ID

They are commonly used among each color space of  $L_vxy$ ,  $L_vu'v'$ ,  $L_vT\Delta uv$ , XYZ, dominant wavelength/excitation purity and spectral graph in one channel.

Calibration channels can be changed using the following procedure.

## Operation Procedure

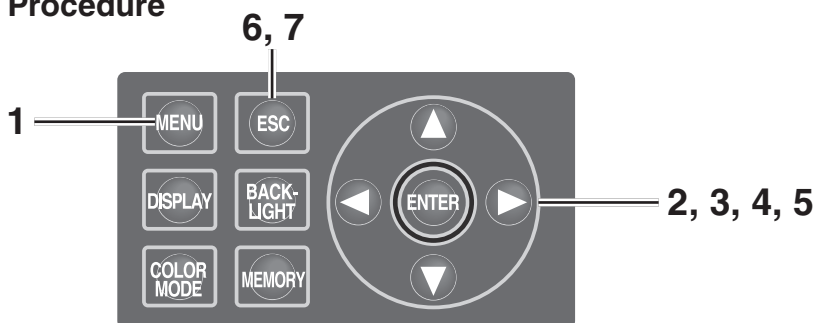

1. Press **MENU** key when the MEAS screen is displayed.

The **MENU** screen appears.

When the backlight of the LCD has been turned off via **BACKLIGHT** key on the MEAS screen, the backlight is turned on.

<MEAS SNGL> UC00 T01			
Lv	35.93	cd/m <sup>2</sup>	
x	0.3968		
y	0.4060		
Obs 2°	SPD Nrm	SYNC Non	LEN Std ND 10 BL on



MENU	
<input type="checkbox"/>	MEAS
<input type="checkbox"/>	MEMORY
<input type="checkbox"/>	TARGET
<input checked="" type="checkbox"/>	OPTION
<input type="checkbox"/>	SETUP

2. Press either **▲** or **▼** key to select **[OPTION]** and then press **ENTER** key.

The **MENU – OPTION** screen appears.

The current set contents are displayed in the **[USER.CAL]** item.

MENU OPTION	
<input checked="" type="checkbox"/>	USER.CAL [NON]
<input checked="" type="checkbox"/>	LENS [STD]
<input checked="" type="checkbox"/>	ND-FILTER [10]
<input type="checkbox"/>	

3. Press either  or  key to select [USER.CAL] and then press **ENTER** key.

The **MENU - OPTION – USER.CAL (Calibration channel selection)** screen appears.

The calibration channel number and compensation coefficient ID (with a maximum of 10 letters) are displayed. In case of Ch00, “NON” is displayed. See instruction manual of CS-S10w for details.

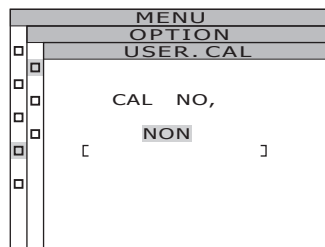

4. Press either  or  key to select the channel.

 key for larger number.

 key for smaller number.

The calibration channel numbers can be selected among NON, and 01 to 10.

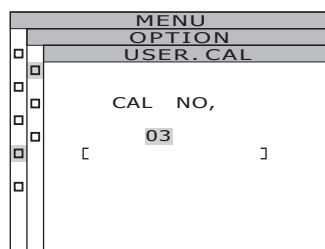

5. Press **ENTER** key.

When the calibration channel is set, the **MENU - OPTION screen** appears again on the LCD.

If the calibration channel without compensation coefficient setting is selected, the setting will not be possible.

By pressing **ESC** key, after the setting is canceled the **MENU - OPTION screen** appears again on the LCD.

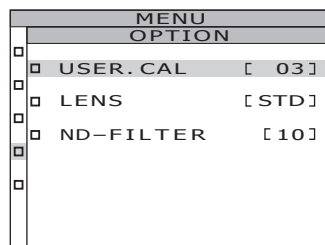

6. Press **ESC** key.

The **MENU screen** appears again on the LCD.

7. Press **ESC** key.

The **MEAS screen** appears again on the LCD.

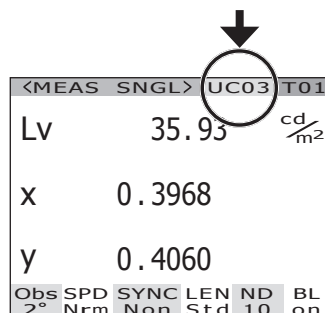

# Backlight ON/OFF During Measurement

The LCD backlight can be selectively turned on or off during measurement. If the backlight is turned off, LCD backlight reflection on the surrounding area affecting the measurement value during measurement can be avoided. If pressing the BACKLIGHT key to turn off the backlight, while the MEAS screen is displayed, the backlight is forcibly turned off independently of the following setting.

\* Factory default setting : ON

## Operation Procedure

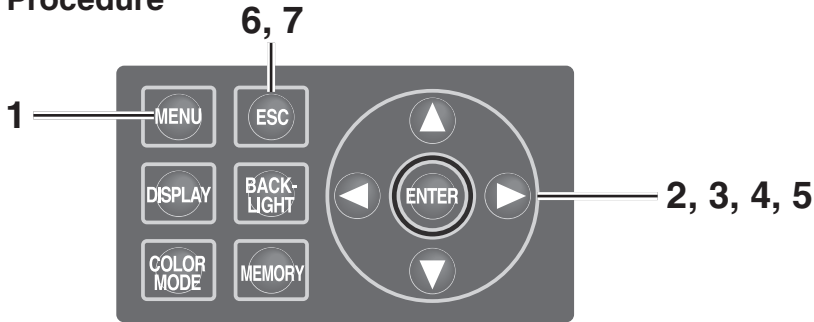

1. Press **MENU** key when the MEAS screen is displayed.

The MENU screen appears.

When the backlight of the LCD has been turned off via **BACKLIGHT** key on the MEAS screen, the backlight is turned on.

<MEAS SNGL>		UC00	T01
Lv	35.93	cd/m <sup>2</sup>	
X	0.3968		
y	0.4060		
Obs	SPD	SYNC	LEN ND
2°	Nrm	Non	Std 10
			BL on

MENU	
<input type="checkbox"/>	MEAS
<input type="checkbox"/>	MEMORY
<input type="checkbox"/>	TARGET
<input type="checkbox"/>	OPTION
<input checked="" type="checkbox"/>	SETUP

2. Press either **▲** or **▼** key to select **[SETUP]** and then press **ENTER** key.

The MENU – SETUP screen appears.

The current set contents are displayed in the **[BACKLIGHT@MEAS]** item.

MENU		SETUP	
<input type="checkbox"/>	OBSERVER	[ 2° ]	
<input checked="" type="checkbox"/>	BACKLIGHT@MEAS	[ ON ]	
<input type="checkbox"/>	DATA FORM	[ F ]	
<input checked="" type="checkbox"/>	RS-232C BAUDRATE	[ 115200bps ]	

3. Press either  $\blacktriangle$  or  $\blacktriangledown$  key to select [BACKLIGHT@MEAS] and then press **ENTER** key.

The MENU - SETUP - BACKLIGHT@MEAS (Turning ON/OFF backlight during measurement) screen appears on the LCD.

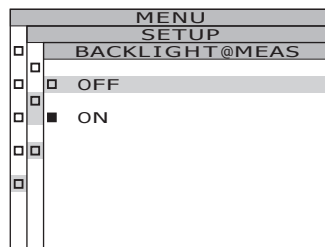

4. Press either  $\blacktriangle$  or  $\blacktriangledown$  key to select [ON] or [OFF].

5. Press **ENTER** key.

When the setting is made to turn the backlight on or off during measurement, the MENU - SETUP screen appears again on the LCD.

By pressing **ESC** key, after the setting is canceled the MENU - SETUP screen appears again on the LCD.

Setting of backlight ON/OFF during measurement is saved even after switching OFF (O).

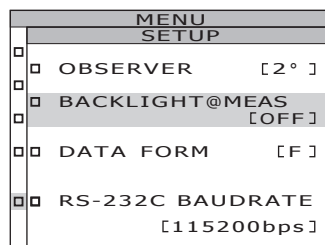

6. Press **ENTER** key.

The MENU screen appears again on the LCD.

7. Press **ESC** key.

The MEAS screen appears again on the LCD.

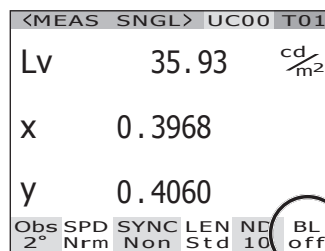

# Baud Rate Selection for RS-232C Communication

The baud rate when connecting to a PC via RS-232C can be set as desired.

\* Baud rate : 600, 1200, 2400, 4800, 9600, 19200, 38400, 57600, 115200

\* Factory default setting : 115200

**Memo** This operation is not necessary when connecting to a PC via USB. In addition, changing the baud rate setting has no effect on USB communication speeds.

## Operating Procedure

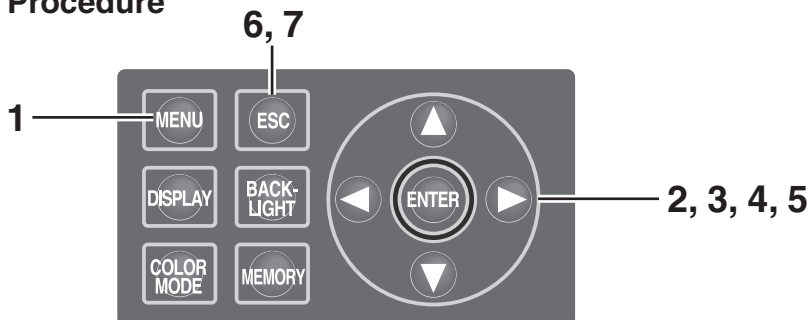

1. Press **MENU** key when the MEAS screen is displayed.

The **MENU** screen appears.

When the backlight of the LCD has been turned off via **BACKLIGHT** key on the MEAS screen, the backlight is turned on.

<MEAS SNGL>		UC00	T01
Lv	35.93		cd/m <sup>2</sup>
X	0.3968		
Y	0.4060		
Obs	SPD	SYNC	LEN ND BL
2°	Nrm	Non	Std 10 on



MENU	
<input type="checkbox"/>	MEAS
<input type="checkbox"/>	MEMORY
<input type="checkbox"/>	TARGET
<input type="checkbox"/>	OPTION
<input checked="" type="checkbox"/>	SETUP

2. Press either **▲** or **▼** key to select **[SETUP]** and then press **ENTER** key.

The **MENU – SETUP** screen appears.

The current set contents are displayed in the **[RS-232C BAUDRATE]** item.

MENU		SETUP	
<input type="checkbox"/>	OBSERVER	[ 2° ]	
<input type="checkbox"/>	BACKLIGHT@MEAS	[ ON ]	
<input type="checkbox"/>	DATA FORM	[ F ]	
<input checked="" type="checkbox"/>	RS-232C BAUDRATE	[ 115200bps ]	

3. Press either  or  key to select [RS-232C BAUDRATE] and then press  key.

The **MENU - SETUP - RS-232C BAUDRATE** (for selection of RS-232C communication baud rate) screen appears.

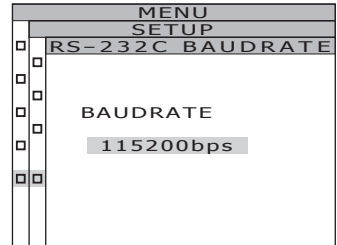

4. Press either  or  key to select the baud rate.

Press  key for larger number.

Press  key for smaller number.

5. Press  key.

When the baud rate is set, the **MENU - SETUP** screen appears again on the LCD.

By pressing  key, after the setting is canceled the **MENU - SETUP** screen appears again on the LCD.

The baud rate setting for RS-232C communication is saved even after switching OFF (O).

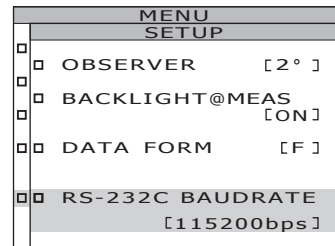

6. Press  key.

The **MENU** screen appears again on the LCD.

# Measurement

# Measurement

## Operation Procedure

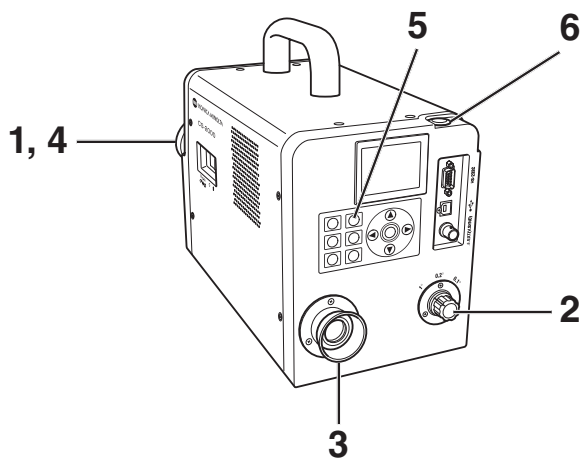

### 1. Decide whether you use closeup lens (optional accessory) or not according to measuring object size and distance.

See the table below for details on measuring distance and measuring area. If you set the closeup lens, lens type setting is required in this instrument. (See p.43)

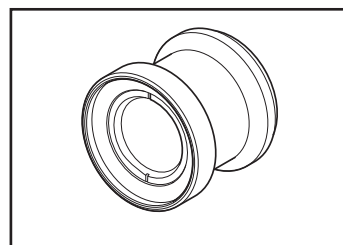

### Measuring distance and measuring area

(Unit: mm)

(Measuring angle)	Minimum measurement diameter $\phi$			Maximum measurement diameter $\phi$			Minimum measurement area			Maximum measurement area			Measuring area when the measuring distance is 500 mm $\phi$			Measuring area when the measuring distance is 1,000 mm $\phi$		
	1°	0.2°	0.1°	1°	0.2°	0.1°	1°	0.2°	0.1°	1°	0.2°	0.1°	1°	0.2°	0.1°	1°	0.2°	0.1°
Without closeup lens	5.00	1.00	0.50	$\infty$	$\infty$	$\infty$	350			$\infty$			7.78	1.56	0.78	16.66	3.33	1.67
With closeup lens	1.00	0.20	0.10	1.39	0.28	0.14	55.0			70.9			-	-	-	-	-	-

\*Measurement distance is the distance from the front edge of the metal lens barrel or closeup lens ring.

### 2. Rotate the measuring angle selector according to size of object and measurement distance, and set the aperture to 1°, 0.2°, or 0.1°.

Do not operate the measuring angle selector during measurement. If measuring angle is switched during measurement, you may fail to perform measurement or to obtain correct measurement value. To rotate the measuring angle selector, move to a position where you can confirm the click. If you stop the selector in a halfway position, measurement may not be performed or wrong measurement values may be obtained.

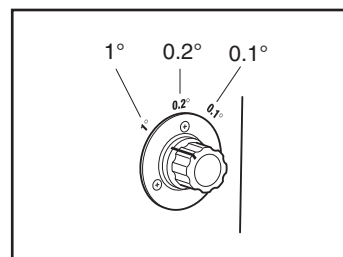



### 3. Rotate the diopter adjustment ring for adjustment of diopter.

Make sure that aperture (black circle indicating measurement area) looks clear when observing object through finder. (See p.15)

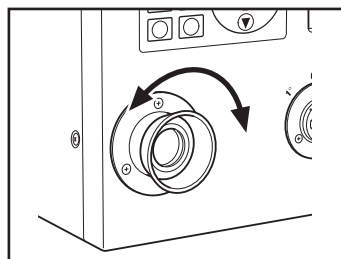

### 4. Rotate the focus adjustment ring for objective lens for that purpose.

Make sure that object around aperture looks clear when observing object through finder. Only measuring area for measuring object must be placed in aperture. If extra area, which is not measuring object, is included in aperture, you cannot perform correct measurement.

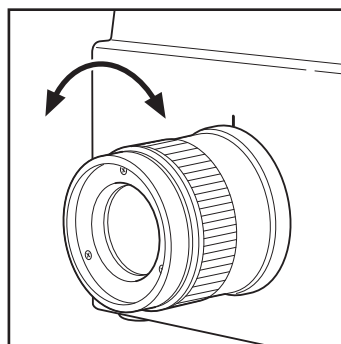

### 5. When the MENU or MEMORY screen is displayed, press **[ESC]** key to switch to the MEAS screen.

The MEAS (Measurement value) screen appears.

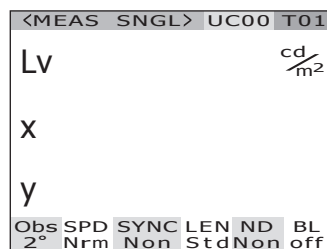

Display during measurement (Single measurement/when measurement time is long)

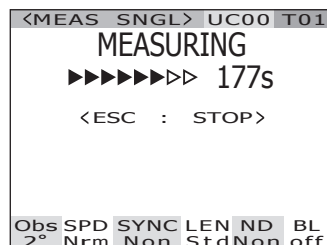

(Single measurement/when measurement time is short)

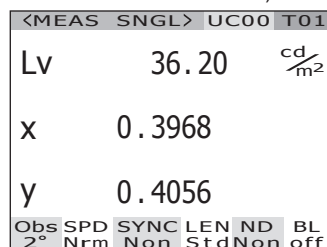

### 6. Press the measurement button.

When the measurement time is long, the measurement progress bar is displayed on the LCD until measurement is complete.

If the measurement time is set to options other than [MANUAL], the measurement time will be determined after the approximate luminance is checked inside the measurement device. For this reason, it may take several seconds until the measurement time appears. The displayed time shows approximately how long it will take from the point of time display to the end of measurement.

If the measurement time determined from the approximate luminance is short, the remaining time will not be displayed.



# Saving the Measurement Value

This instrument can save 100 measurement values with designated numbers from 00 to 99.

## Operation Procedure

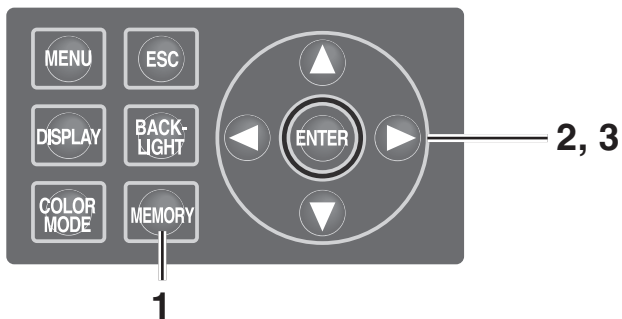

1. When the MEAS screen is displayed, press **MEMORY** key to switch to the **MEMORY** screen.

The **MEMORY (Memory data)** screen appears.  
The memory data number 00 is displayed.

<b>&lt;MEMORY &gt;</b>			
<b>&lt;MEAS &gt;</b>			
Lv	36.20		cd/m <sup>2</sup>
x	0.3968		
y	0.4056		
<b>&lt;MEMORY 00 &gt;</b>			
Lv	34.22		cd/m <sup>2</sup>
x	0.3958		
y	0.4060		
Obs SPD SYNC LEN ND BL			
2° Nrm Non StdNon off			

2. Press either **▲** or **▼** key to select the number of memory data.

**▲** key for larger number.  
**▼** key for smaller number.

<b>&lt;MEMORY &gt;</b>			
<b>&lt;MEAS &gt;</b>			
Lv	36.20		cd/m <sup>2</sup>
x	0.3968		
y	0.4056		
<b>&lt;MEMORY 02 &gt;</b>			
Lv			cd/m <sup>2</sup>
x			
y			
Obs SPD SYNC LEN ND BL			
2° Nrm Non StdNon off			

3. Press **ENTER** key.

Each measurement value is saved with the selected number.

If **ESC** key is pressed, saving is canceled and the **MEAS** screen appears on the LCD.

<b>&lt;MEMORY &gt;</b>			
<b>&lt;MEAS &gt;</b>			
Lv	36.20		cd/m <sup>2</sup>
x	0.3968		
y	0.4056		
<b>&lt;MEMORY 02 &gt;</b>			
Lv	36.20		cd/m <sup>2</sup>
x	0.3968		
y	0.4056		
Obs SPD SYNC LEN ND BL			
2° Nrm Non StdNon off			

Use the following procedure to display the memory data properties (measurement conditions):

### Operation Procedure

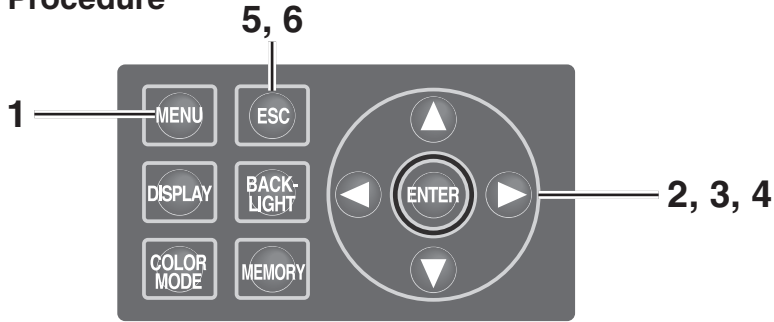

1. Press **MENU** key when the MEAS screen is displayed.

The **MENU** screen appears.

When the backlight of the LCD has been turned off via **BACKLIGHT** key on the MEAS screen, the backlight is turned on.

<MEAS SNGL> UC00 T01		
Lv	35.93	cd/m <sup>2</sup>
X	0.3968	
Y	0.4060	
Obs	SPD	SYNC LEN ND BL
2°	Nrm	Non StdNon off

MENU	
<input type="checkbox"/>	MEAS
<input checked="" type="checkbox"/>	MEMORY
<input type="checkbox"/>	TARGET
<input type="checkbox"/>	OPTION
<input type="checkbox"/>	SETUP

2. Press either **▲** or **▼** key to select **[MEMORY]** and then press **ENTER** key.

The **MENU – MEMORY** screen appears.

MENU MEMORY	
<input type="checkbox"/>	DELETE
<input checked="" type="checkbox"/>	PROPERTIES
<input type="checkbox"/>	
<input type="checkbox"/>	

3. Press either **▲** or **▼** key to select **[PROPERTIES]** and then press **ENTER** key.

The **MENU – MEMORY – PROPERTIES (Memory data measurement condition confirmation)** screen appears.

The memory data number 00 is displayed.

MENU MEMORY PROPERTIES	
<input type="checkbox"/>	<MEMORY 00 >
<input checked="" type="checkbox"/>	ANGLE 1.0°
<input type="checkbox"/>	SPEED NORMAL
<input type="checkbox"/>	SYNC NO SYNC
<input type="checkbox"/>	LENS STANDARD
<input type="checkbox"/>	FILTER NONE
<input type="checkbox"/>	IN-ND OFF
	INTG 66.667ms

- 
4. To display the memory data for another number, press either ▲ or ▼ key to change the memory data number.

The properties of the selected memory data are displayed, and the measurement conditions can be confirmed.

▲ key for larger number.

If kept pressed, the value continuously changes.

▼ key for smaller number.

If kept pressed, the value continuously changes.

MENU MEMORY PROPERTIES	
<MEMORY	02
ANGLE	1.2°
SPEED	NORMAL
SYNC	NO SYNC
LENS	STANDARD
FILTER	NONE
IN-ND	OFF
INTG	66.667ms

5. Press **ESC** key.

The **MENU – MEMORY** screen appears again on the LCD.

6. Press **ESC** key.

The **MEAS** screen appears again on the LCD.

# Deleting the Memory Data

Stored measurement values can be deleted in the following procedure.

## Operation Procedure

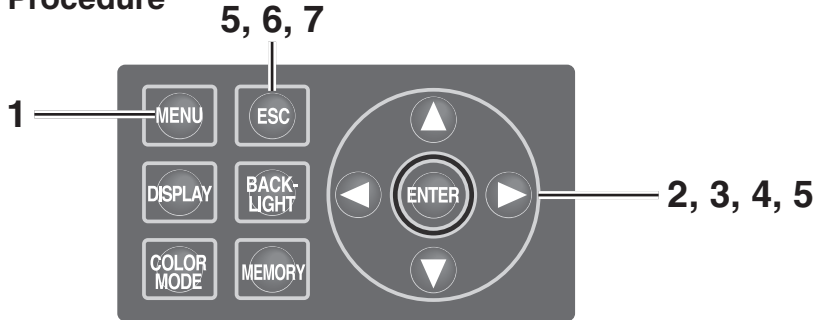

1. Press **MENU** key when the MEAS screen is displayed.

The MENU screen appears.

When the backlight of the LCD has been turned off via **BACKLIGHT** key on the MEAS screen, the backlight is turned on.

<MEAS SNGL> UC00 T01		
LV	35.93	cd/m <sup>2</sup>
X	0.3968	
Y	0.4060	
Obs	SPD	SYNC LEN ND BL
2°	Nrm	Non StdNon off

MENU	
<input type="checkbox"/>	MEAS
<input checked="" type="checkbox"/>	MEMORY
<input type="checkbox"/>	TARGET
<input type="checkbox"/>	OPTION
<input type="checkbox"/>	SETUP

2. Press either **▲** or **▼** key to select **MEMORY** and then press **ENTER** key.

The MENU – MEMORY screen appears.

MENU MEMORY	
<input checked="" type="checkbox"/>	DELETE
<input type="checkbox"/>	PROPERTIES
<input type="checkbox"/>	
<input type="checkbox"/>	

3. Press either **▲** or **▼** key to select **DELETE** and then press **ENTER** key.

The MENU – MEMORY – DELETE (Memory data deletion) screen appears.

The memory data number 00 is displayed.

MENU MEMORY MEM, DELETE	
<input checked="" type="checkbox"/>	MEM, DATA NO, 00
<input type="checkbox"/>	
<input type="checkbox"/>	LV 34.22
<input type="checkbox"/>	X 0.3958
<input type="checkbox"/>	Y 0.4060

**4. Press either ▲ or ▼ key to select the number of memory data you want to delete.**

▲ key for larger number. If kept pressed, the value continuously changes. [ALL] is displayed after No.99.

▼ key for smaller number. If kept pressed, the value continuously changes. [ALL] is displayed after No.00.

The deleted memory data can not be recovered. Confirm the number before deleting the memory data.

MENU	
MEMORY	
MEM, DELETE	
MEM, DATA NO, 02	
LV	36.20
X	0.3968
Y	0.4056

**5-a-1. Deletion of saved data, one by one: Select the number of the memory data to be deleted, and press **ENTER** key.**

The saved measurement value disappears. By pressing **ESC** key, the deletion of the memory data is canceled and the **MENU - MEMORY** screen appears again on the LCD.

MENU	
MEMORY	
MEM, DELETE	
MEM, DATA NO, 02	
LV	
X	
Y	

**5-a-2. Repeat the steps 4 through 5-a-1. as necessary.**

**5-a-3. Press **ESC** key.**

The **MENU - MEMORY** screen appears again on the LCD.



**5-b-1. Collective deletion of all memory data: Select [ALL] and press **ENTER** key.**

The confirmation screen for deletion of all memory data is displayed.

MENU	
MEMORY	
MEM, DELETE	
MEM, DATA NO, ALL	
LV	36.20
X	0.3968
Y	0.4056

---

**5-b-2. Press  key to select [OK] and then press  key.**

All memory data are deleted, and the **MENU - MEMORY** screen appears again on the LCD. By selecting **[CANCEL]** and pressing  key, or pressing  key, the deletion of all memory data is canceled and the **MENU - MEMORY** screen appears again on the LCD.

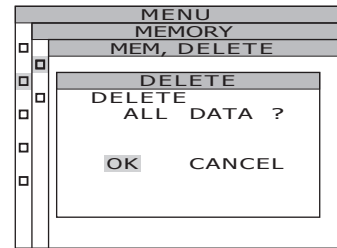

.....

**6. Press  key.**

The **MENU – MEMORY** screen appears again on the LCD.

**7. Press  key.**

The **MEAS** screen appears again on the LCD.



# Registering Target Color

## Target color

The target color serves as reference for measurement of deviation of measured color from reference.

Target colors can be registered up to 20 from Ch 01 to Ch 20 completely within this instrument.

To register the target color:

- (1) Register the measurement value
- (2) Select from the memory data
- (3) Enter the numerical value

To change the previously set target color, select another target color. User calibration correction coefficient will not be influenced despite of target color change.

The target color is commonly used among each color space of  $L_vxy$ ,  $L_vu'v'$ ,  $L_vT\Delta uv$ , XYZ, dominant wavelength/excitation purity and spectral graph.

## Operation Procedure

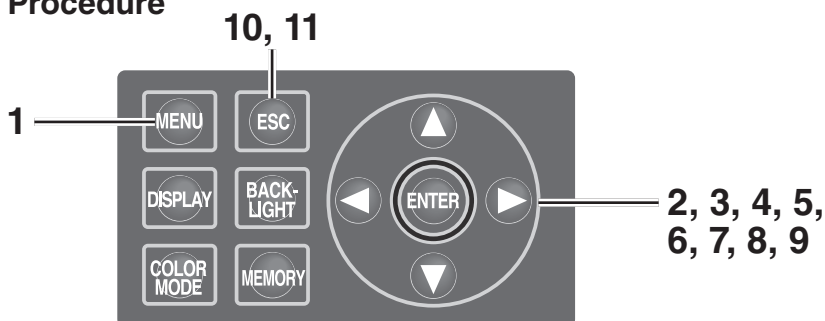

### 1. Press **MENU** key when the MEAS screen is displayed.

The **MENU** screen appears.

When the backlight of the LCD has been turned off via **BACKLIGHT** key on the MEAS screen, the backlight is turned on.

<MEAS SNGL>		UC00	T01
Lv	35.93		$\frac{cd}{m^2}$
X	0.3968		
y	0.4060		
Obs	SPD	SYNC	LEN ND
2°	Nrm	Non	StdNon
			BL off

MENU	
<input type="checkbox"/>	MEAS
<input type="checkbox"/>	MEMORY
<input checked="" type="checkbox"/>	TARGET
<input type="checkbox"/>	OPTION
<input type="checkbox"/>	SETUP

- Press either **▲** or **▼** key to select **[TARGET]** and then press **[ENTER]** key.

The **MENU – TARGET** screen appears.

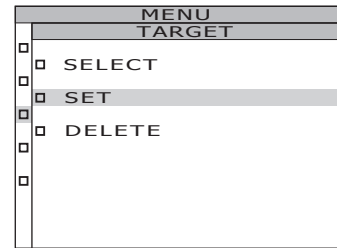

- Press either **▲** or **▼** key to select **[SET]** and then press **[ENTER]** key.

The **MENU – TARGET – SET** screen appears.

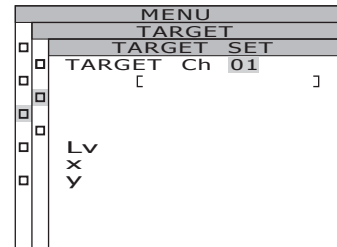

- Change target color channels by pressing **▲** or **▼** key, and select the channel used to register a target color.

**▲** key for larger number. If kept pressed, the number continuously increases.

**▼** key for smaller number. If kept pressed, the number continuously decreases.

Once a target color is registered, the status before registration cannot be restored. If the target colors are changed by overwriting, confirm the channel number before making the change.

- Press **[ENTER]** key.

The screen used for input of the target color ID appears on the LCD.

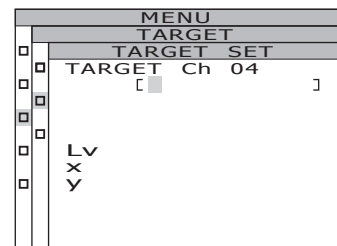

- Enter the target color ID.

When the **▲** key is pressed, the characters change among 0 to 9, a to z, A to Z, and space.

When the **▼** key is pressed, the characters change among space, Z to A, z to a, and 9 to 0.

When **▶** key is pressed, the cursor moves to the right by one position.

When **◀** key is pressed, the cursor moves to the left by one position.

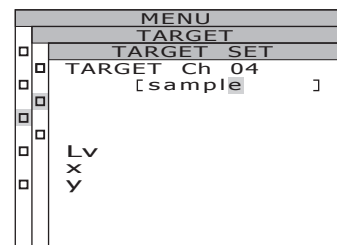

## 7. Press **[ENTER]** key.

The screen used to select a target color appears on the LCD.

By pressing **[ESC]** key, the input of the target color is canceled and the **MENU - TARGET screen** appears again on the LCD.

MENU	
TARGET	
TARGET SET	
TARGET Ch 04	[sample ]
<SOURCE >	MES
Lv	36.20
X	0.3968
Y	0.4056

## 8. Press either **▲** or **▼** key to select data to be a target color.

When the **▲** key is pressed, values are changed among, M00 to M99, EDT, and MES. If kept pressed, the value continuously changes.

When the **▼** key is pressed, values are changed among MES, EDT, and M00 to M99. If kept pressed, the value continuously changes.

### 9-a-1. Selection of a measurement value as a target color: Select **[MES]** and press **[ENTER]** key.

When the target color is registered, the **MENU - TARGET screen** appears again on the LCD.

By pressing **[ESC]** key, the registration of the target color is canceled and the **MENU - TARGET screen** appears again on the LCD.

MENU	
TARGET	
TARGET SET	
TARGET Ch 04	[sample ]
<SOURCE >	MES
Lv	36.20
X	0.3968
Y	0.4056

### 9-b-1. Selection of a memory data as a target color: Select from **[M00~M99]** and press **[ENTER]** key.

When the target color is registered, the **MENU - TARGET screen** appears again on the LCD.

By pressing **[ESC]** key, the registration of the target color is canceled and the **MENU - TARGET screen** appears again on the LCD.

MENU	
TARGET	
TARGET SET	
TARGET Ch 04	[sample ]
<SOURCE >	M00
Lv	35.93
X	0.3968
Y	0.4060

### 9-c-1. Manual input of a target color: Select **[EDT]** and press **[ENTER]** key.

The screen used to input a target color with a numerical value appears on the LCD.

MENU	
TARGET	
TARGET SET	
TARGET Ch 04	[sample ]
<SOURCE >	EDT
Lv	0.0000E+0
X	0.0000
Y	0.0000

## 9-c-2. Enter the target color.

▲ key for larger number.

If kept pressed, the value continuously increases.

▼ key for smaller number.

If kept pressed, the value continuously becomes small.

When ► key is pressed, the cursor moves to the right by one position.

When ◀ key is pressed, the cursor moves to the left by one position.

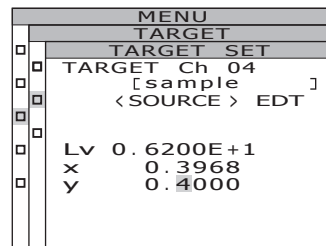

MENU	
TARGET	
TARGET SET	
TARGET Ch	04
[sample	]
<SOURCE>	EDT
LV	0.6200E+1
X	0.3968
Y	0.4000

## 9-c-3. Press **ENTER** key.

When the target color is registered, the **MENU - TARGET screen** appears again on the LCD.

When observer angle is  $10^\circ$ , Y is displayed instead of  $L_v$  and registered as  $Y_{10}$ .

If the entered value does not establish a proper combination with the value in the color space mode, the cursor will move to the first digit on the first line. Enter another value again.

By pressing **ESC** key, the registration of the target color is canceled and the **MENU - TARGET screen** appears again on the LCD.

.....

## 10. Press **ESC** key.

The **MENU screen** appears again on the LCD.

## 11. Press **ESC** key.

The **MEAS screen** appears again on the LCD.

# Selecting Target Color

Select a target color for color-difference measurement from the channels Ch01 to Ch20. The new set color is also applied to the measurement value displayed on the current MEAS screen.

## Operation Procedure

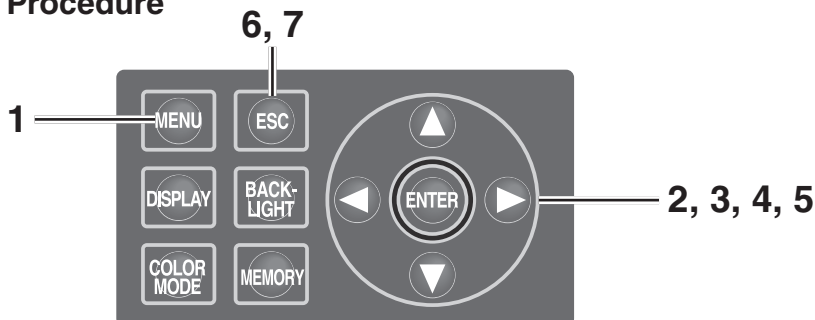

1. Press **MENU** key when the MEAS screen is displayed.

The **MENU** screen appears.

When the backlight of the LCD has been turned off via **BACKLIGHT** key on the MEAS screen, the backlight is turned on.

<MEAS SNGL> UC00 T01			
Lv	36.20	$\frac{cd}{m^2}$	
X	0.3968		
y	0.4056		
Obs	SPD	SYNC	LEN ND
2°	Nrm	Non	StdNon
			BL off

MENU	
<input type="checkbox"/>	MEAS
<input type="checkbox"/>	MEMORY
<input checked="" type="checkbox"/>	TARGET
<input type="checkbox"/>	OPTION
<input type="checkbox"/>	SETUP

2. Press either **▲** or **▼** key to select **[TARGET]** and then press **ENTER** key.

The **MENU – TARGET** screen appears.

MENU TARGET	
<input checked="" type="checkbox"/>	SELECT
<input type="checkbox"/>	SET
<input type="checkbox"/>	DELETE
<input type="checkbox"/>	
<input type="checkbox"/>	

3. Press either **▲** or **▼** key to select **[SELECT]** and then press **ENTER** key.

The **MENU – TARGET – SELECT** screen appears.

MENU TARGET SELECT	
<input checked="" type="checkbox"/>	TARGET SELECT
<input checked="" type="checkbox"/>	TARGET Ch01
<input type="checkbox"/>	[ ]
<input type="checkbox"/>	
<input type="checkbox"/>	Lv
<input type="checkbox"/>	X
<input type="checkbox"/>	y
<input type="checkbox"/>	

**4. Press either  $\blacktriangle$  or  $\blacktriangledown$  key to switch the target color channel.**

$\blacktriangle$  key for larger number.

If kept pressed, the number continuously increases.

$\blacktriangledown$  key for smaller number.

If kept pressed, the number continuously decreases.

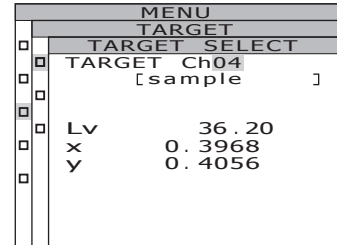

MENU	
TARGET	
TARGET SELECT	
TARGET Ch04	[sample ]
Lv	36.20
X	0.3968
Y	0.4056

**5. Press **ENTER** key.**

When the target color is set, the **MENU - TARGET** screen appears again on the LCD.

By pressing **ESC** key, the selection of the target color is canceled and the **MENU - TARGET** screen appears again on the LCD.

**6. Press **ESC** key.**

The **MENU** screen appears again on the LCD.

**7. Press **ESC** key.**

The **MEAS** screen appears again on the LCD.

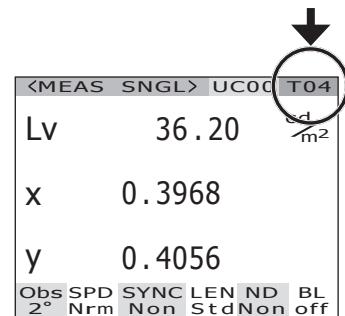

<MEAS SNGL> UC00		T04
Lv	36.20	$\frac{cd}{m^2}$
X	0.3968	
Y	0.4056	
Obs	SPD	SYNC
2°	Nrm	Non
	Len	Std
	ND	Non
	BL	off

# Deleting Target Color

The registered target color can be deleted in the following procedure.

## Operation Procedure

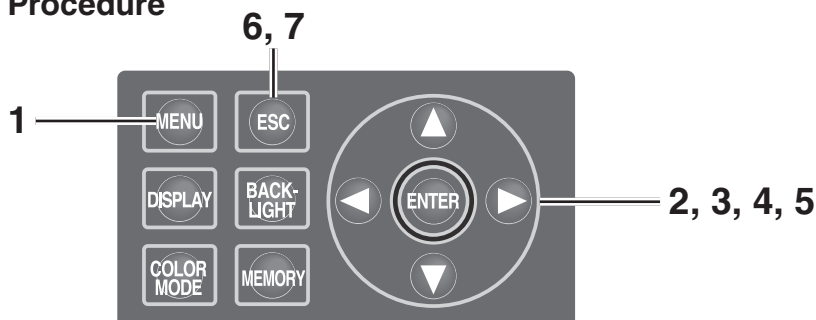

1. Press **MENU** key when the MEAS screen is displayed.

The **MENU** screen appears.

When the backlight of the LCD has been turned off via **BACKLIGHT** key on the MEAS screen, the backlight is turned on.

<MEAS SNGL> UC00 T01		
Lv	35.93	cd/m <sup>2</sup>
X	0.3968	
Y	0.4060	
Obs	SPD	SYNC LEN ND BL
2°	Nrm	Non StdNon off

MENU	
<input type="checkbox"/>	MEAS
<input type="checkbox"/>	MEMORY
<input checked="" type="checkbox"/>	TARGET
<input type="checkbox"/>	OPTION
<input type="checkbox"/>	SETUP

2. Press either **▲** or **▼** key to select **[TARGET]** and then press **ENTER** key.

The **MENU – TARGET** screen appears.

MENU TARGET	
<input type="checkbox"/>	SELECT
<input type="checkbox"/>	SET
<input checked="" type="checkbox"/>	DELETE
<input type="checkbox"/>	
<input type="checkbox"/>	

3. Press either **▲** or **▼** key to select **[DELETE]** and then press **ENTER** key.

The **MENU – TARGET – DELETE (Target color deletion)** screen appears.

MENU TARGET DELETE	
<input type="checkbox"/>	TARGET Ch01
<input type="checkbox"/>	[ ]
<input type="checkbox"/>	
<input type="checkbox"/>	Lv
<input type="checkbox"/>	X
<input type="checkbox"/>	Y

- 4.** Press either **▲** or **▼** key and select the number to delete the desirable memory data or **[ALL]**. Press **ENTER** key.

**▲** key for larger number. If kept pressed, the value continuously changes. **[ALL]** is displayed after Ch 20.

**▼** key for smaller number. If kept pressed, the value continuously changes. **[ALL]** is displayed after Ch 00.

The confirmation screen to delete the target color appears.

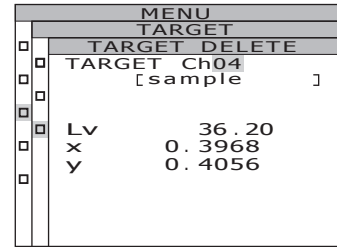

- 5.-a-1.** Deletion of target colors one by one:

Press **◀** key to select **[OK]** and then press **ENTER** key.

The display of the registered target color disappears.

By selecting **[CANCEL]** and pressing **ENTER** key, or pressing **ESC** key, the deletion of the target color is canceled and the **MENU - TARGET** screen appears again on the LCD.

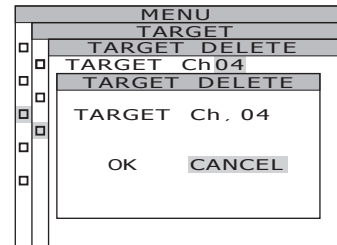

- 5.-a-2.** To delete another target color continuously, repeat the steps 4 through 5-a-1. as necessary.

- 5.-a-3.** Press **ESC** key.

The **MENU – TARGET** screen appears again on the LCD.



## 5.-b-1. Collective deletion of all target colors:

◀ key to select [OK] and then press **ENTER** key.

When all target colors are deleted, the **MENU - TARGET** screen appears again on the LCD.

By selecting [**CANCEL**] and pressing **ENTER** key, or pressing **ESC** key, the deletion of the target color is canceled and the **MENU - TARGET** screen appears again on the LCD.

By pressing **ESC** key, the selection of the target color is canceled and the **MENU - TARGET** screen appears again on the LCD.

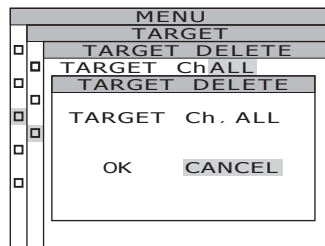

## 6. Press **ESC** key.

The **MEAS** screen appears again on the LCD.

## 7. Press **ESC** key.

The **MEAS** screen appears again on the LCD.



# Communication

# Connecting to PC

This instrument can be used together with PC for mutual communication. To communicate with a PC, use the included USB cable (2 m) CS-A32 or an optional RS-232C cable (IF-A37/38).

**Memo** Simultaneous use of USB communication and RS communication is not possible.

## Connection via USB cable

The USB cable is allowed to plug/unplug while power is on, but it is recommended to switch power off in this case.

**Memo** Make sure to attach the RS-232C connector cap. Failure to do so may cause malfunction due to static electricity.

## Operation Procedure

- 1. Switch power OFF (O).**
- 2. Connect the USB cable to the USB connector of this instrument.**
- 3. Make sure that USB cable is all seated to the USB connector.**

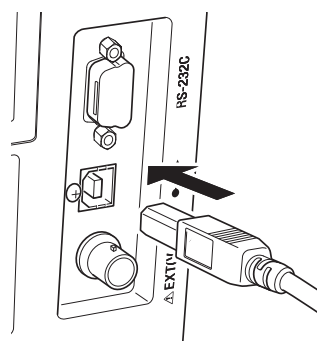

Communication interface in this instrument conforms to USB1.1.

Hold the USB cable plug in unplugging. Do not pull the cord.

Plug the USB cable to fit the connector entry point.

To connect this instrument to PC, install the corresponding USB driver software. It is attached to the data management software CS-S10w Professional in the standard accessories. See installation guide of CS-S10w Professional for details on installing the USB driver software to PC.

## Connection via RS-232C cable

Before setting the power switch to ON ( | ), connect an RS-232C cable (9-pin D-sub) to the RS-232C connector on the instrument.

The RS-232C connector on the instrument is a 9-pin D-sub male connector. Use a cross cable for the connector.

### Operating Procedure

- 1.** Slide power switch to OFF (O).
- 2.** Connect the instrument to the PC using an RS-232C cable.
- 3.** Make sure that the cable is firmly connected to the RS-232C connector with the connector's right and left screws.

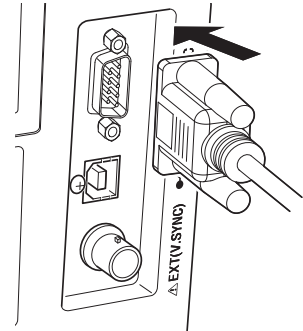

When disconnecting the RS-232C cable, slide power switch to OFF (O) first, and pull the cable by holding the plug. Never pull the cable by its cord.

Baud rate	600/1200/2400/4800/9600/19200/38400/57600/115200
Data length	8 bits
Parity	None
Stop bit	1 bit
Flow control	Hardware (RTS/CTS)

Pin arrangement

Device side

PC side

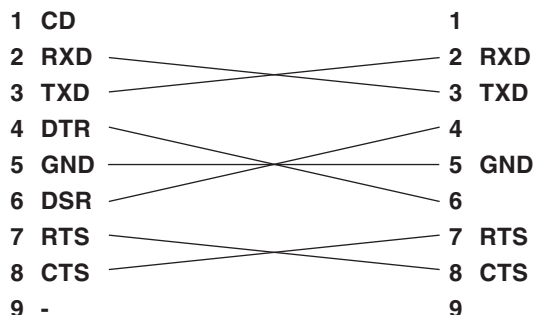

Cross cable

# Remote Mode

Remote mode refers to sending command from PC to this instrument with both connected.

If this instrument is controlled with PC, “**REMOTE MODE**” appears on the LCD. While this message is displayed, key operation of this instrument is not acceptable except for following cases.

- If the measurement button is pressed, measurement starts to forward the data to PC. (in case that measurement button is in valid mode by transferring command from PC to this instrument. Use data management software below.)
- When **ESC** key is pressed, the remote mode is canceled.

To control this instrument with PC, use the data management software CS-S10w Professional in the standard accessories. See instruction manual of CS-S10w Professional for details on the specifications and usage.

If you want to use an independent program on PC to control this instrument, download Communication Specifications from KONICA MINOLTA’s website at URL below for your reference

<http://konicaminolta.com/instruments/download/software/index.html>

(The above URL is subject to change without notice.)

(If the target page will not appear, please search the site by keywords, CS-2000 and download.)

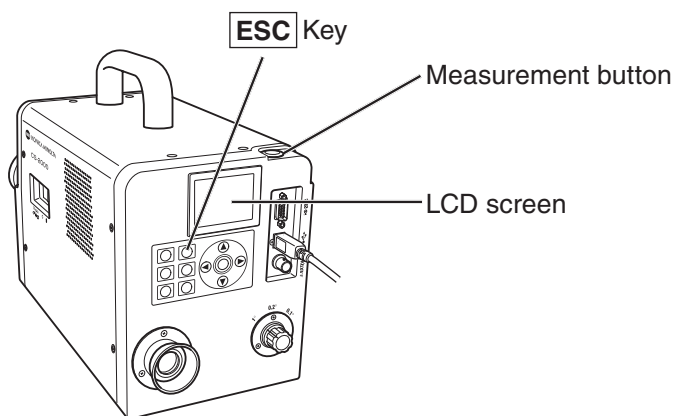

**Memo** Use USB when controlling the instrument with CS-S10w.

# Explanation

# Measurement Principle

---

Light energy passes through the objective lens. The lights from the measurement area pass through the hole in the center of the aperture mirror to the optical fiber, while the remaining light is guided to the finder optics by the aperture mirror. As a result, the part equivalent to the measurement area looks like a black circle when observed through the finder.

The light entering the optic fiber is reflected repeatedly so that it is mixed and becomes virtually uniform. It then passes through the collimator lens to the plane diffraction grating. After being dispersed by the grating, the light is focused by the condenser lens according to wavelength. An array sensor is located at this focus point.

The amount of detected energy for each wavelength is then converted to a digital value by an A/D converter, based on which the spectral radiant luminance and chromaticity are calculated by the processing section of the CS-2000.

## Sensor Section

The sensor section has a photo diode array consisting of 512 elements. The array is always kept at constant temperature using a Peltier cooler, irrespective of the ambient temperature. This can reduce dark current and improve S/N ratio, thus enabling measurement of low luminance.

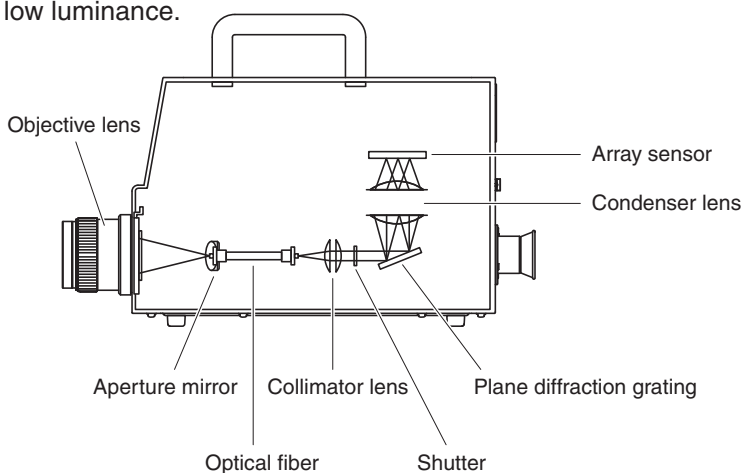

## Dark Measurement

---

Each measurement consists of “light measurement” and “dark measurement”.

“Light measurement” is performed with light from the object irradiating the sensor, while “dark measurement” is performed with no light from the object irradiating the sensor, so that detector dark current is measured.

When measurement starts, first “light measurement” is performed. When “light measurement” is complete, the shutter will close automatically, then “dark measurement” starts immediately. “Dark measurement” is performed with the same integration time used for “light measurement”. The final measured data is obtained by subtracting the measured data obtained in “dark measurement” from the one obtained in “light measurement”. This method eliminates influences of dark current of the array sensor, resulting in improved measurement accuracy.



# $L_v T \Delta uv$

Following factors can be acquired as measurement value with  $L_v T \Delta uv$  as color space of this instrument.

- $L_v$  : Luminance
- $T$  : Correlated color temperature
- $\Delta uv$  : Color difference from blackbody locus

While  $L_{vs}$  stands for luminance,  $T$  and  $\Delta uv$  for color in  $L_v T \Delta uv$ .

## <Relation between correlated color temperature $T$ and color difference from blackbody locus $\Delta uv$ >

Color temperature refers to the temperature of black body (perfect radiator) which has equal chromaticity coordinates to certain light. However, color temperature only represents colors on blackbody locus.

Correlated color temperature, slightly wider interpretation of color temperature, is very useful to eliminate such problem. Here, correlated color temperature covers those which are slightly outside the range of that of blackbody locus.

If a certain color positions on isothermperature line, the intersection point of isothermperature line and blackbody locus is indicated as correlated color temperature for the color.

Isothermperature line means line on chromaticity coordinates which is a set of colors visually close to color temperature on blackbody locus.

However, since all colors on a color-matching temperature line are represented with equal correlated color temperature, it is not possible to describe color only with correlated color temperature. To solve that,  $\Delta uv$ , deviation of correlated color temperature  $T$  from blackbody locus, is to apply for that purpose.

If  $\Delta uv$  exists above blackbody locus, it is represented with "+", and below, with "-".

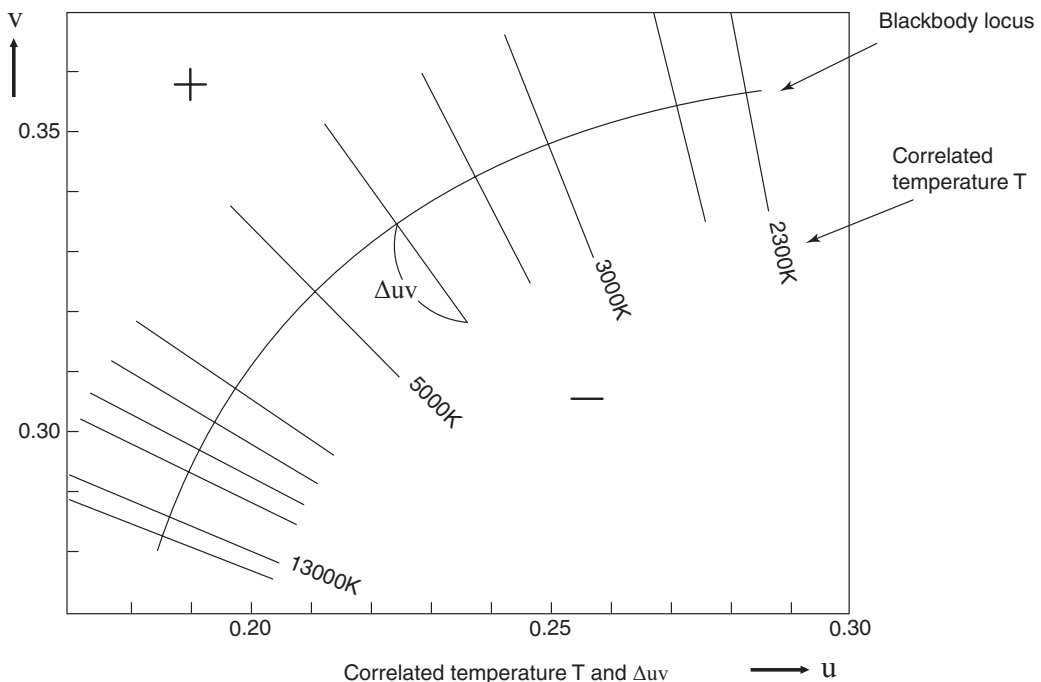

# Dominant wavelength/Excitation purity

In the x, y chromaticity diagram shown below, the curve VS<sub>c</sub>SR is the spectrum locus, and point N is the white point.

Colors located in the region enclosed by the spectrum locus and the straight lines VN and NR are referred to as spectral colors; colors located in the triangle NVR with the white point N at the apex and the pure purple line VR as the base are referred to as nonspectral colors.

### <Dominant wavelength and excitation purity (spectral colors)>

When the chromaticity point obtained by the measurement is C, the wavelength corresponding to the intersection point S of the extension of NC with the spectrum locus (curve VS<sub>c</sub>SR) is referred to as the dominant wavelength and indicated by the symbol λ<sub>d</sub>. The ratio of the lengths of the straight lines NC and NS is referred to as the excitation purity of color excitation C and indicated by the symbol p<sub>e</sub>.

### <Complementary wavelength (non-spectral colors)>

When the chromaticity point obtained by measurement is C', the extension of NC' toward C' does not intersect with the spectrum locus but only the pure-purple lines. In this case the wavelength corresponding to the intersection point S<sub>c</sub> of the extension of NC' toward N with the spectrum locus is referred to as the complementary wavelength and indicated by the symbol λ<sub>c</sub>. When the intersection point of the extension of the line NC' with the line VR (pure-purple locus) is designated by S', the ratio of the lengths of NC' to NS' is referred to as excitation purity and indicated by the symbol p'<sub>v</sub>.

The following equations are formulated, if each point is designated as the following coordinates: (x<sub>n</sub>, y<sub>n</sub>): chromaticity coordinate of point N; (x<sub>c</sub>, y<sub>c</sub>): chromaticity coordinate of point C; (x<sub>λ</sub>, y<sub>λ</sub>): chromaticity coordinate of point S, (x'<sub>c</sub>, y'<sub>c</sub>): chromaticity coordinate of point C', and (x<sub>p</sub>, y<sub>p</sub>): chromaticity coordinate of point:

Excitation purity (spectral colors)

$$p_e = \frac{x_c - x_n}{x - x_n} = \frac{y_c - y_n}{y - y_n}$$

Excitation purity (non-spectral colors)

$$p_{e'} = \frac{x'_c - x_n}{x_p - x_n} = \frac{y'_c - y_n}{y_p - y_n}$$

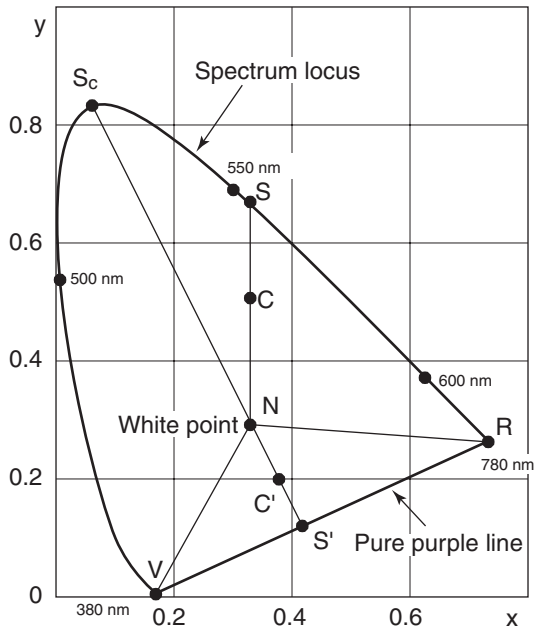

Dominant wavelength on chromaticity diagram

# Measurement of Object Color

Use of the data management software CS-S10w Professional in the standard accessories enables simple measurement of the color of the object. Measured data is evaluated based on luminance which has been stored as light source data in CS-S10w. See instruction manual of CS-S10w for details.

- Set while calibration plate (optional accessory) and object on the same position with the same angle from this instrument. Uniform illumination and measurement conditions of white calibration plate and those of object. If not, measurement data may vary, causing incorrect data.
- Keep illumination light source as stable as possible with fixed voltage power source during measurement.

## Measurement Procedure

### Necessary Setting for Object Color Measurement

#### 1. Set one or more tungsten lumps or equivalent as illumination source toward white calibration plate as in the right illustration.

- Set this instrument vertical to white calibration plate.
- Keep the angle between illumination light source and white calibration plate at 45°.

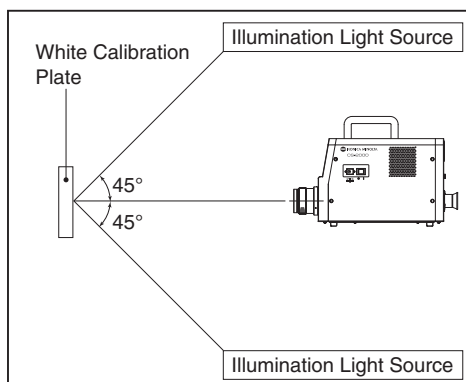

#### 2. Start up this instrument, PC, and software CS-S10w.

### White Calibration

#### 3. Set the document type to “object color” with CS-S10w.

#### 4. Conduct white calibration with CS-S10w.

### Measurement of Object

#### 5. Set object on the same position and at the same angle as white calibration plate.

#### 6. Conduct measurement with CS-S10w.

◆ See instruction manual of data management software CS-S10w for details.

# Dimensions

(Unit: mm)

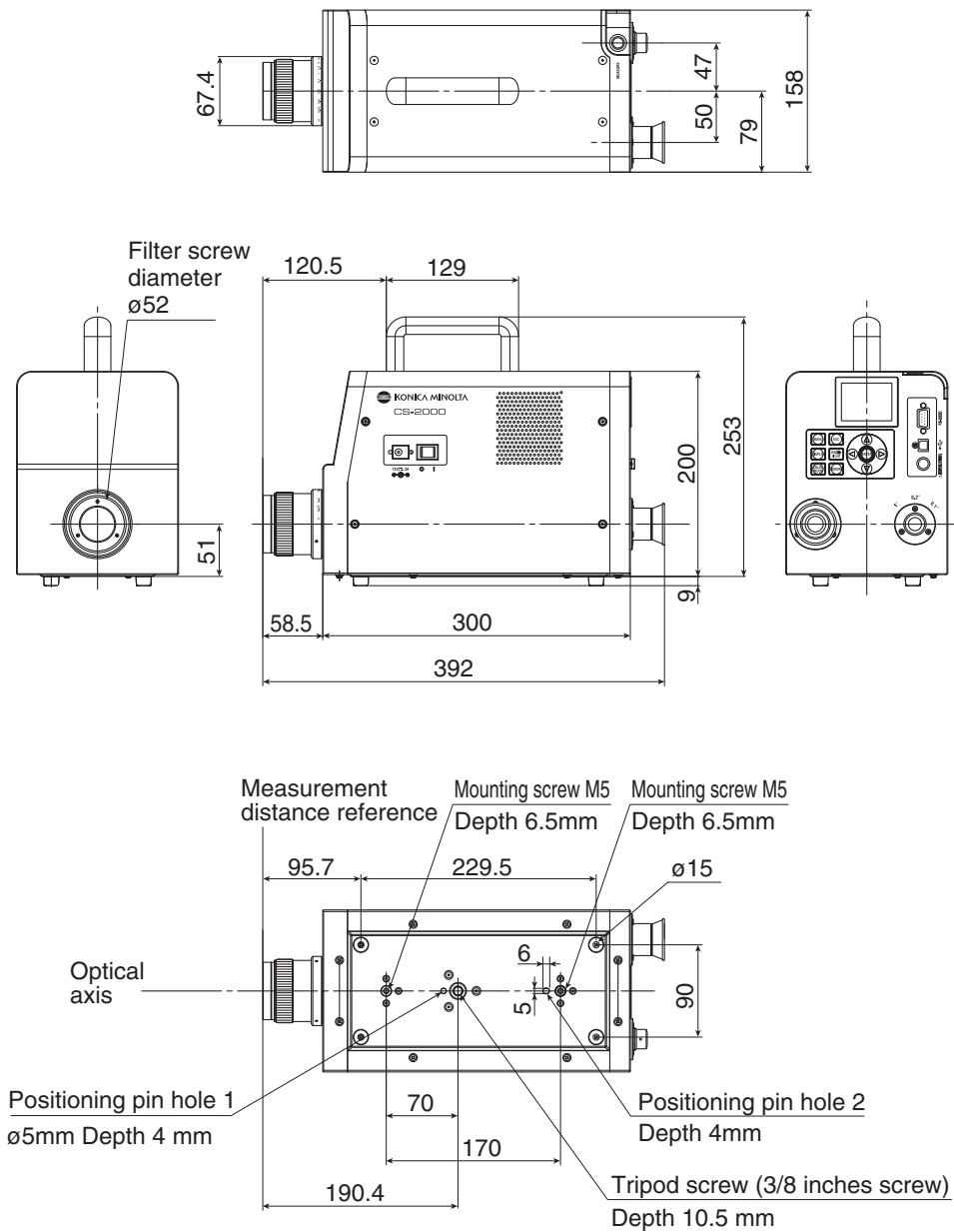

# Error Message

Error message appears on the LCD when this instrument does not operate normally. Below table shows type of error message, its description and corrective action respectively.

	Error Message	Cause (Description)	Corrective action
1	MEMORY ERROR	Data stored in ROM is damaged.	<ul style="list-style-type: none"> <li>• Turn on the power switch again.</li> <li>• If the symptoms are not remedied, please contact the nearest KONICA MINOLTA authorized service facility.</li> </ul>
2	OVER	<p>Luminance of measuring object is higher than the available range.</p> <p>Flicker of measuring object is high.</p>	<ul style="list-style-type: none"> <li>• Use the ND filter and re-measure.</li> <li>• Decrease the measuring area and re-measure.</li> <li>• If the symptoms are not remedied, please contact the nearest KONICA MINOLTA authorized service facility.</li> <li>• Set the flicker cycle in INT SYNC mode, or input the flicker signal in EXT SYNC mode.</li> </ul>
3	SYNC ERROR	<p>Input signal in EXT SYNC mode is not at CMOS level.</p> <p>Input signal in EXT SYNC mode exceeds 200 Hz.</p> <p>Input signal in EXT SYNC mode is less than 20 Hz.</p>	<ul style="list-style-type: none"> <li>• Input a signal with 3.5 to 5.0 V at high level; 0.0 to 1.5 V at low level.</li> <li>• Set the frequency value divided by an integer in INT SYNC mode and re-measure.</li> <li>• Set the integral multiple value of the input signal cycle in INT SYNC mode and re-measure using the MULTI INTEG-NORMAL mode or MULTI INTEG-FAST mode.</li> <li>• Set the integral multiple value of the input signal cycle in INT SYNC mode and re-measure using the MANUAL mode.</li> </ul>
4	VIEWING-ANGLE SELECTOR ERROR	Measurement was performed when the measuring angle selector was in the wrong position, or its position was changed during measurement.	<ul style="list-style-type: none"> <li>• Switch the measuring angle selector and re-measure. Or, do not operate the measuring angle selector during measurement.</li> <li>• If the symptoms are not remedied, please contact the nearest KONICA MINOLTA authorized service facility.</li> </ul>
5	TEMPERATURE ERROR	The ambient temperature for the measurement device is too high, and an internal temperature of the sensor becomes abnormal.	<ul style="list-style-type: none"> <li>• Decrease the ambient temperature to enable cooling to within the specified temperature.</li> </ul>
6	FAN ERROR	The cooling fan stops, or the cooling device has an error.	<ul style="list-style-type: none"> <li>• Decrease the ambient temperature to enable cooling to within the specified temperature.</li> <li>• Turn off the power switch once, turn it on again after a while.</li> <li>• If the symptoms are not remedied, the fan must be repaired. Please contact the nearest KONICA MINOLTA authorized service facility.</li> </ul>

# Error Check

Should any errors be found in this instrument, try the corrective actions shown in the following table. If this does not help, it's possible the instrument is broken. Please contact the nearest KONICA MINOLTA authorized service facility with the error number and version of your instrument. To confirm the instrument version, see p.23.

Error No.	Symptom	Item to Check	Corrective Action	Reference Page
1	No display on the LCD after power is turned on.	Has the AC adapter been properly plugged into the AC outlet?	Connect the AC adapter.	21
		Has the AC adapter been connected to this instrument?	Connect the AC adapter.	21
		Has a wrong AC adapter been connected?	Be sure to use the AC adapter and power cord supplied as a standard or optional accessory (AC-A312).	21
		Is AC power source within rated scale?	Use within $\pm 10\%$ of the nominal voltage.	21
2	Nothing is visible through the finder.	Is the lens cap still attached to the objective lens?	Remove the lens cap.	8
		Is the ND filter attached to the objective lens?	Use the ND filter when the luminance of that being measured is too high.	9, 45
		Is the ND eyepiece filter attached to the finder?	Use the ND eyepiece filter when luminance of that being measured is too high.	9, 45
3	Nothing is displayed on the LCD.	Is the backlight set to OFF?	Press <b>BACKLIGHT</b> key to turn ON the backlight.	14, 49
		Has the backlight been set to OFF during measurement?	In the menu operation, set the backlight to ON during measurement	49
4	Does not accept key operation.	Has the remote mode been set?	Press <b>ESC</b> key to cancel the remote mode.	76
		Have you pressed a disabled key?	Press the correct key.	—
5	Measurement unavailable even if the measurement button is pressed.	Has a screen other than MENU been displayed?	Conduct measurement when the MEAS screen is displayed.	55
6	The entered value for target color is different from the one that will be displayed after setting.		A 1-digit difference may be found due to calculation error.	63
7	Measurement values do not appear.	Is there data?	Conduct measurement.	54
		Has the color space mode become color temperature?	Color temperature is displayed as " _ _ _ " if it is far from the blackbody locus. Change the display using the other color space mode and check.	39
		Did you interrupt measurement?	Conduct measurement again.	54

Error No.	Symptom	Item to Check	Corrective Action	Reference Page
8	Measurement values are inconsistent.	Is the measuring object stable?	Conduct measurement with the measuring object stable.	—
		Is the measuring object of low luminance?	Repeatability of x, y worsens if the measuring object of low luminance is measured.	54, 29
			It especially worsens when the measurement angle is 0.2° or 0.1°.	
			It also worsens when the measurement time is short. Make the measurement time longer.	
		Is the measurement sync frequency appropriate when measuring the display?	Set the appropriate measurement sync frequency.	26, 31
			Use MULTI INTEG-NORMAL mode or MULTI INTEG-FAST mode.	
			Measure in EXT SYNC mode.	
Have the ambient temperature and /or humidity changed rapidly?	Conduct measurement under an environment free from rapid changes in ambient temperature and humidity.	3		
Did you start measurement immediately after startup?	Allow the instrument to warm up for 20 minutes or more when the power switch is turned on.	23		
9	Measurement values appear incorrectly.	Is the objective lens clean?	Wipe off the lens with a dry, soft cloth or lens cleaning paper.	4
		User calibration may not be performed correctly.	Check the values without user calibration (i.e. set the calibration channel to 00 (NON) and check).	47
		Is the calibration channel correct?	Select the calibration channel according to the light source of luminance and chroma close to the object.	47
		Has the closeup lens been attached?	Select the lens type setting according to the attached closeup lens.	43, 54
		Has the ND filter been attached?	Select the ND filter setting according to the attached ND filter.	45
		Has the object been focused?	Adjust the focus after adjusting the diopter.	13, 15, 55

Error No.	Symptom	Item to Check	Corrective Action	Reference Page
10	The measurement stops halfway and does not finish in the set measurement time.	Is the measuring object of high luminance?	When measuring an object of high luminance, the sensor may be saturated by exceeding the upper limit of the current measurement setting. Use the ND filter.	45
11	Actual measurement time is different from the displayed measurement time.		The displayed measurement time is the remaining time. The actual measurement time may be different from the displayed time depending on the mode setting of measurement time.	31
12	Measurement value on the LCD disappears.	Has the power source been supplied securely?	Connect to a stable power source and insert the AC adapter plug securely.	21
		Did you interrupt the measurement?	When starting continuous measurement, press the measurement button securely. Do not press <b>[ESC]</b> key.	56
13	During USB communication: Cannot download data output from this instrument on the PC. Cannot enter commands or data from the PC to this instrument.	Has the USB cable been connected securely?	Connect this instrument and the PC securely.	74
		Has the USB cable been disconnected?	Replace the USB cable.	—
		Has remote mode been canceled?	Send the connection command from the PC to this instrument and switch to remote mode. Use the data management software CS-S10w in the standard accessories.	76
		Has the program been prepared correctly?	Refer to communication specifications and check the program. Use the data management software CS-S10w in the standard accessories.	—
		Is RS communication being used?	Simultaneous use of RS communication and USB communication is not possible. Press <b>[ESC]</b> key to exit remote mode, and then restart communication via USB only.	—
14	An instrument malfunction has occurred (including errors 1 through 13).	Has the RS-232C connector been touched? Is the cap attached?	Turn the instrument off and back on to restart. Accidentally touching the RS-232C connector can cause malfunction due to static electricity, so be sure to attach the cap.	74



Error No.	Symptom	Item to Check	Corrective Action	Reference Page
15	Data output by the instrument during RS communication cannot be imported to the PC. Commands and data cannot be input from the PC to the instrument.	Has the RS cable been connected securely?	Connect this instrument and the PC securely.	75
		Has the RS cable been disconnected?	Replace the RS cable.	—
		Has remote mode been canceled?	Send the connection command from the PC to this instrument and switch to remote mode.	—
		Has the program been prepared correctly?	Refer to communication specifications and check the program.	—
		Is USB communication being used?	Simultaneous use of RS communication and USB communication is not possible. Press <b>ESC</b> key to exit remote mode, and then restart communication via RS only.	—
16	Same error message appears repeatedly.	Check the appropriate corrective action for the error message.	If the symptoms are not remedied, please contact the nearest KONICA MINOLTA authorized service facility.	—

# Setting Initialization

Preset measurement conditions can be initialized to the factory default settings according to the following procedure.

Factory default settings are shown below.

* Synchronizing method	: NO SYNC	* Measurement time	: MULTI INTEG, 1s, IN-ND: AUTO
* Observer	: 2°OBS	* Display format	: ****.**** [F]
* Color space mode	: L <sub>v</sub> xy	* Absolute value (ABS)/ Difference (DIFF) display	: Absolute value (ABS)
* Lens type	: STANDARD	* ND filter type	: NONE
* Backlight during measurement	: ON		
* RS-232C communication baud rate	: 115200 bps		

## Operation Procedure

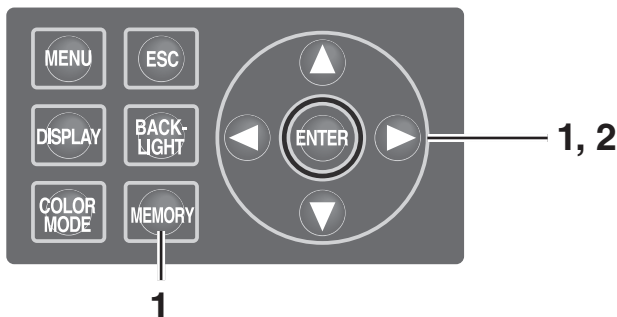

1. When the power switch is OFF (O), turn it to ON (I) while pressing **MEMORY** key, **▲** key and **▼** key simultaneously.

The **INITIALIZE SETTINGS (confirmation of setting initialization)** screen appears approx. 5 seconds after the initial screen on the LCD.

Continue pressing **MEMORY** key, **▲** key and **▼** key until the **INITIALIZE SETTINGS** screen appears.



2. Press **◀** key to select [OK] and then press **ENTER** key.

The preset measurement conditions are initialized and the **MEAS** screen appears on the LCD.

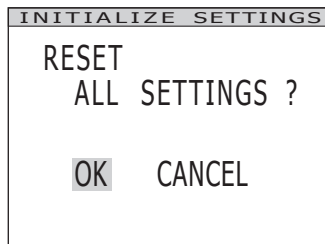

# Switching Luminance Unit

You can select [cd/m<sup>2</sup>] or [ fL ] as the luminance unit.

## Operation Procedure

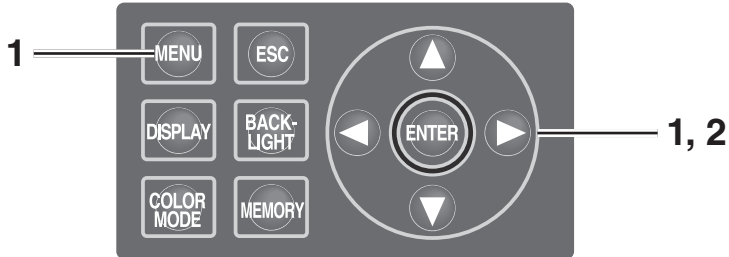

- 1.** When the power switch is OFF (O), turn it to ON ( I ) while pressing **MENU** key and **▼** key simultaneously.

The **Luminance Unit (switching luminance unit) screen** appears approx. 5 seconds after the initial screen on the LCD.

Continue pressing **MENU** key and **▼** key until the **Luminance Unit screen** appears.

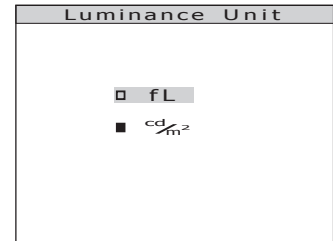

- 2.** Press either **▲** or **▼** key to select the luminance unit and then press **ENTER** key.

The setting is entered and the **MEAS screen** appears on the LCD.

# Main Specifications

Model	CS-2000		
Wavelength range	380 to 780 nm		
Wavelength resolution	0.9 nm/pixel		
Display wavelength bandwidth	1.0 nm		
Wavelength precision	±0.3 nm (median wavelength: 435.8 nm, 546.1 nm, 643.8 nm Hg-Cd lamp)		
Spectral bandwidth	5 nm or less (half bandwidth)		
Measuring angle (selectable)	1°	0.2°	0.1°
Measurement luminance range (Standard light source A)	0.003 to 5,000 cd/m <sup>2</sup>	0.075 to 125,000 cd/m <sup>2</sup>	0.3 to 500,000 cd/m <sup>2</sup>
Minimum measuring area	ø5 mm (ø1 mm when using closeup lens)	ø1 mm (ø0.2 mm when using closeup lens)	ø0.5 mm (ø0.1 mm when using closeup lens)
Minimum measuring distance	350 mm (55 mm when using closeup lens)		
Minimum spectral radiance display	1.0×10 <sup>-9</sup> W/(sr · m <sup>2</sup> · nm)		
Accuracy: Luminance (Standard light source A) <sup>*1</sup>	±2%		
Accuracy: Chromaticity (Standard light source A) <sup>*1</sup>	x,y : ±0.003 (0.003 to 0.005 cd/m <sup>2</sup> ) x,y : ±0.002 (0.005 to 0.05 cd/m <sup>2</sup> ) x : ±0.0015 (0.05 cd/m <sup>2</sup> or more) y : ±0.001	x,y : ±0.003 (0.075 to 0.125 cd/m <sup>2</sup> ) x,y : ±0.002 (0.125 to 1.25 cd/m <sup>2</sup> ) x : ±0.0015 (1.25 cd/m <sup>2</sup> or more) y : ±0.001	x,y : ±0.003 (0.3 to 0.5 cd/m <sup>2</sup> ) x,y : ±0.002 (0.5 to 5 cd/m <sup>2</sup> ) x : ±0.0015 (5 cd/m <sup>2</sup> or more) y : ±0.001
Repeatability: Luminance (2 σ) (Standard light source A) <sup>*2</sup>	0.4% (0.003 to 0.05 cd/m <sup>2</sup> ) 0.3% (0.05 to 0.1 cd/m <sup>2</sup> ) 0.15% (0.1 to 5,000 cd/m <sup>2</sup> )	0.4% (0.075 to 1.25 cd/m <sup>2</sup> ) 0.3% (1.25 to 2.5 cd/m <sup>2</sup> ) 0.15% (2.5 to 125,000 cd/m <sup>2</sup> )	0.4% (0.3 to 5 cd/m <sup>2</sup> ) 0.3% (5 to 10 cd/m <sup>2</sup> ) 0.15% (10 to 500,000 cd/m <sup>2</sup> )
Repeatability: Chromaticity (2 σ) (Standard light source A) <sup>*2</sup>	x,y : 0.002 (0.003 to 0.005 cd/m <sup>2</sup> ) x,y : 0.001 (0.005 to 0.1 cd/m <sup>2</sup> ) x,y : 0.0006 (0.1 to 0.2 cd/m <sup>2</sup> ) x,y : 0.0004 (0.2 to 5,000 cd/m <sup>2</sup> )	x,y : 0.002 (0.075 to 0.125 cd/m <sup>2</sup> ) x,y : 0.001 (0.125 to 2.5 cd/m <sup>2</sup> ) x,y : 0.0006 (2.5 to 5 cd/m <sup>2</sup> ) x,y : 0.0004 (5 to 125,000 cd/m <sup>2</sup> )	x,y : 0.002 (0.3 to 0.5 cd/m <sup>2</sup> ) x,y : 0.001 (0.5 to 10 cd/m <sup>2</sup> ) x,y : 0.0006 (10 to 20 cd/m <sup>2</sup> ) x,y : 0.0004 (20 to 500,000 cd/m <sup>2</sup> )
Polarization error	1°: 2% or less (400 to 780 nm); 0.1° and 0.2°: 3% or less (400 to 780 nm)		
Integration time	Fast: 0.005 to 16 sec.; Normal: 0.005 to 120 sec.		
Measurement time	Approx. 2 sec. min. (Manual mode) to 243 sec. max. (Normal mode)		
Color space mode	L <sub>v</sub> x y, L <sub>v</sub> u'v', L <sub>v</sub> T Δuv, XYZ, dominant wavelength, spectral graph, excitation purity, scotopic luminosity (with CS-S10w Professional)		
Interface	USB 1.1, RS-232C		
Operating temperature/humidity range	5 to 35°C, relative humidity 80% or less with no condensation		
Storage temperature/humidity range	0 to 35°C, relative humidity 80% or less with no condensation		
Power	Dedicated AC adapter (100 to 240 V ~, 50/60 Hz)		
Power consumption	Approx. 20 W		
Size	158 (W) × 262 (H) × 392 (D) mm		
Weight	Approx. 7.0 kg		

\*1: Average of 10 measurements in Normal mode at a temperature of 23±2°C and a relative humidity of 65% or less.

\*2: 10 measurements in Normal mode at a temperature of 23±2°C and a relative humidity of 65% or less.

Model	CS-2000A		
Wavelength range	380 to 780 nm		
Wavelength resolution	0.9 nm/pixel		
Display wavelength bandwidth	1.0 nm		
Wavelength precision	±0.3 nm (median wavelength: 435.8 nm, 546.1 nm, 643.8 nm Hg-Cd lamp)		
Spectral bandwidth	5 nm or less (half bandwidth)		
Measuring angle (selectable)	1°	0.2°	0.1°
Measurement luminance range (Standard light source A)	0.0005 to 5,000 cd/m <sup>2</sup>	0.0125 to 125,000 cd/m <sup>2</sup>	0.05 to 500,000 cd/m <sup>2</sup>
Minimum measuring area	ø5 mm (ø1 mm when using closeup lens)	ø1 mm (ø0.2 mm when using closeup lens)	ø0.5 mm (ø0.1 mm when using closeup lens)
Minimum measuring distance	350 mm (55 mm when using closeup lens)		
Minimum spectral radiance display	1.0×10 <sup>-9</sup> W/(sr · m <sup>2</sup> · nm)		
Accuracy: Luminance (Standard light source A) <sup>*1</sup>	±2%		
Accuracy: Chromaticity (Standard light source A) <sup>*1</sup>	x,y : ± 0.002 (0.001 to 0.05 cd/m <sup>2</sup> ) x : ± 0.0015 (0.05 cd/m <sup>2</sup> or more) y : ± 0.001 (0.05 cd/m <sup>2</sup> or more)	x,y : ± 0.002 (0.025 to 1.25 cd/m <sup>2</sup> ) x : ± 0.0015 (1.25 cd/m <sup>2</sup> or more) y : ± 0.001 (1.25 cd/m <sup>2</sup> or more)	x,y : ± 0.002 (0.1 to 5 cd/m <sup>2</sup> ) x : ± 0.0015 (5 cd/m <sup>2</sup> or more) y : ± 0.001 (5 cd/m <sup>2</sup> or more)
Repeatability: Luminance (2 σ) (Standard light source A) <sup>*2</sup>	1.5 % (0.0005 to 0.001 cd/m <sup>2</sup> ) 0.7 % (0.001 to 0.003 cd/m <sup>2</sup> ) 0.25 % (0.003 to 0.05 cd/m <sup>2</sup> ) 0.15 % (0.05 to 5,000 cd/m <sup>2</sup> )	1.5 % (0.0125 to 0.025 cd/m <sup>2</sup> ) 0.7 % (0.025 to 0.075 cd/m <sup>2</sup> ) 0.25 % (0.075 to 1.25 cd/m <sup>2</sup> ) 0.15 % (1.25 to 125,000 cd/m <sup>2</sup> )	1.5 % (0.05 to 0.1 cd/m <sup>2</sup> ) 0.7 % (0.1 to 0.3 cd/m <sup>2</sup> ) 0.25 % (0.3 to 5 cd/m <sup>2</sup> ) 0.15 % (5 to 500,000 cd/m <sup>2</sup> )
Repeatability: Chromaticity (2 σ) (Standard light source A) <sup>*2</sup>	x : 0.003 y : 0.0035 (0.001 to 0.003 cd/m <sup>2</sup> ) x : 0.001 y : 0.0015 (0.003 to 0.1 cd/m <sup>2</sup> ) x, y : 0.0006 (0.1 to 0.2 cd/m <sup>2</sup> ) x, y : 0.0004 (0.2 to 5,000 cd/m <sup>2</sup> )	x : 0.003 y : 0.0035 (0.025 to 0.075 cd/m <sup>2</sup> ) x : 0.001 y : 0.0015 (0.075 to 2.5 cd/m <sup>2</sup> ) x, y : 0.0006 (2.5 to 5 cd/m <sup>2</sup> ) x, y : 0.0004 (5 to 125,000 cd/m <sup>2</sup> )	x : 0.003 y : 0.0035 (0.1 to 0.3 cd/m <sup>2</sup> ) x : 0.001 y : 0.0015 (0.3 to 10 cd/m <sup>2</sup> ) x, y : 0.0006 (10 to 20 cd/m <sup>2</sup> ) x, y : 0.0004 (20 to 500,000 cd/m <sup>2</sup> )
Polarization error	1°: 2% or less (400 to 780 nm); 0.1° and 0.2°: 3% or less (400 to 780 nm)		
Integration time	Fast: 0.005 to 16 sec.; Normal: 0.005 to 120 sec.		
Measurement time	Approx. 2 sec. min. (Manual mode) to 247 sec. max. (Normal mode)		
Color space mode	L <sub>v</sub> x y, L <sub>v</sub> u'v', L <sub>v</sub> TΔuv, XYZ, dominant wavelength, spectral graph, excitation purity, scotopic luminosity (with CS-S10w Professional)		
Interface	USB 1.1, RS-232C		
Operating temperature/humidity range	5 to 30°C, relative humidity 80% or less with no condensation		
Storage temperature/humidity range	0 to 35°C, relative humidity 80% or less with no condensation		
Power	Dedicated AC adapter (100 to 240 V ~, 50/60 Hz)		
Power consumption	Approx. 20 W		
Size	158 (W) × 262 (H) × 392 (D) mm		
Weight	Approx. 7.0 kg		

\*1: Average of 10 measurements in Normal mode at a temperature of 23±2°C and a relative humidity of 65% or less.

\*2: 10 measurements in Normal mode at a temperature of 23±2°C and a relative humidity of 65% or less.



KONICA MINOLTA